

IP VIDEO PRODUCT SELECTION

2018 Ver. 3

Network Cameras / PTZ / NVR / Display & Control / Transmission / Accessories / Video Management Software / DORI Distance



CONTENTS



03

NETWORK CAMERAS

Ultra-Smart Series / Panoramic Series / Pinhole Series /
Eco-Savvy 3.0 Series / Lite H.265 Series / Access ANPR Cameras

22

NETWORK PTZ CAMERAS

Ultra Series / Pro Series / Lite Series / Wi-Fi Series / Positioning Systems



35

NETWORK VIDEO RECORDERS

Ultra Series / Pro Series / Lite H.265 Series

47

DISPLAY & CONTROL

49

TRANSMISSION / ACCESSORIES / VIDEO MANAGEMENT
SOFTWARE / DORI DISTANCE (D/O/R/I)



NETWORK CAMERAS



Ultra-Smart Series

The Ultra Series is an ideal option for surveillance professionals committed to employing the latest innovations and highest performance with the highest quality assurance in the surveillance industry. A Sony STARVIS sensor, superior Starlight technology, and advanced intelligent functions ensure top-grade monitoring in any scenario.

⊕ KEY FEATURES

High-Performance

Super-sensitive Sony STARVIS™ sensor for unparalleled performance

Superior Image

Starlight / Ultra 140dB WDR provides clear image under any light conditions

H.265





Advanced encoding saves up to 50% bandwidth and storage

Intelligent Functions

People Counting, heat map, and SSA to greatly increase efficiency

Ultra-Smart Series

Box Camera

Model	IPC-HF81230E-E	IPC-HF8835F	IPC-HF8630F-E	IPC-HF8331F-E
Appearance	 4K H.265+	 4K H.265+ Starlight+	 H.265+	 Ultra WDR H.265+ Starlight
Image Sensor	1/1.7" 12MP STARVIS™ CMOS	4/3" 8MP CMOS	1/1.8" 6MP STARVIS™ CMOS	1/2.8" 3MP STARVIS™ CMOS
Lens	CS	M43	CS	CS
FOV-H	--	--	--	--
Min. Illumination	0.005Lux/F1.2(Color,1/3s,30IRE) 0.05Lux/F1.2(Color,1/30s,30IRE) 0.003Lux/F1.2(B/W,1/3s,30IRE) 0.03Lux/F1.2(B/W,1/30s,30IRE)	0.0005Lux/F0.95 (Color,1/3s,30IRE) 0.003Lux/F0.95 (Color,1/30s,30IRE)	0.005Lux/F1.2(Color,1/3s,30IRE) 0.05Lux/F1.2(Color,1/30s,30IRE) 0.003Lux/F1.2(B/W,1/3s,30IRE) 0.03Lux/F1.2(B/W,1/30s,30IRE)	0.002Lux/F1.2(Color,1/3s,30IRE) 0.02Lux/F1.2(Color,1/30s,30IRE) 0.001Lux/F1.2(B/W,1/3s,30IRE) 0.01Lux/F1.2(B/W,1/30s,30IRE)
Day/Night	ICR	ICR	ICR	ICR
WDR	DWDR	140dB	DWDR	140dB
Max. IR Distance	--	--	--	--
Video Compression	H.265+/H.265/H.264+/H.264	H.265+/H.265/H.264+/H.264	H.265+/H.265/H.264+/H.264	H.265+/H.265/H.264+/H.264
Max. Resolution	12MP(4000×3000)	4K(3840×2160)	6MP(3072×2048)	3MP(2048×1536)
Frame Rate	20fps@12MP, 30fps@4K	30fps@4K	30fps@6MP	60fps@3MP
Multi-streaming	3 streams	3 streams	3 streams	3 streams
Pan/Tilt/Rotation	--	--	--	--
Intelligent Video	Tripwire, Intrusion Scene Change Abandoned/Missing Face Detection People Counting, Heat Map	Tripwire, Intrusion Scene Change Abandoned/Missing Face Detection People Counting, Heat Map	Tripwire, Intrusion Scene Change Abandoned/Missing Face Detection People Counting, Heat Map	Tripwire, Intrusion Scene Change Abandoned/Missing Face Detection People Counting, Heat Map
Compatibility	ONVIF profile S&G, API	ONVIF profile S&G, API	ONVIF profile S&G, API	ONVIF profile S&G, API
Audio In/Out	1/1, Built-in Mic	2/1,Built-in Mic	2/1, Built-in Mic	2/1, Built-in Mic
Memory Slot	Micro SD, Max. 128GB	Micro SD, Max. 128GB	Micro SD, Max. 128GB	Micro SD, Max. 128GB
Alarm In/Out	2 channel In: 5mA 5VDC 1 channel Out: 1A 30VDC / 0.5A 50VAC	2 channel In: 5mA 5VDC 2 channel Out: 1A 30VDC / 0.5A 50VAC	2 channel In: 5mA 5VDC 2 channel Out: 1A 30VDC / 0.5A 50VAC	2 channel In: 5mA 5VDC 2 channel Out: 1A 30VDC / 0.5A 50VAC
Ingress Protection	--	--	--	--
Working Temperature	-30°C~+60°C(-22°F ~ +140°F)	-30°C~+60°C(-22°F ~ +140°F)	-30°C~+60°C(-22°F ~ +140°F)	-30°C~+60°C(-22°F ~ +140°F)
Power	DC12V/AC24V PoE (802.3af)(Class 0) Max. 8W	DC12V/AC24V PoE (802.3af)(Class 0) Max. 6.5W	DC12V/AC24V PoE (802.3af)(Class 0) Max. 7W	DC12V/AC24V PoE (802.3af)(Class 0) Max. 6.6W

NETWORK CAMERAS

Ultra-Smart Series

	Box Camera		Vari-Focal Bullet			
Model	IPC-HF8232F-E	IPC-HF8231F-E	IPC-HFW81230E-ZE	IPC-HFW8630E-ZE	IPC-HFW8331E-ZE/Z5E	IPC-HFW8232E-ZE
Appearance	 ePoE H.265+ Starlight	 ePoE Ultra WDR H.265+ Starlight	 ePoE 4K H.265+	 ePoE H.265+	 ePoE Ultra WDR H.265+ Starlight	 ePoE H.265+ Starlight
Image Sensor	1/1.9" 2MP Sony CMOS	1/2.8" 2MP STARVIS™ CMOS	1/1.7" 12MP STARVIS™ CMOS	1/1.8" 6MP STARVIS™ CMOS	1/2.8" 3MP STARVIS™ CMOS	1/1.9" 2MP Sony CMOS
Lens	CS	CS	4.1-16.4mm/F1.53(4x Optical zoom)	4.1-16.4mm/F1.53(4x Optical zoom)	2.7~13.5mm/F1.4, Motorized 7~35mm/F1.4, Motorized(Z5)	4.1-16.4mm/F1.53(4x Optical zoom)
FOV-H	--	--	105°~35°	105°~34°	99°~28° 32°~11°(Z5)	104°~33°
Min. Illumination	0.001Lux/F1.2(Color,1/3s,30IRE) 0.01Lux/F1.2(Color,1/30s,30IRE) 0.0005Lux/F1.2(B/W,1/3s,30IRE) 0.005Lux/F1.2(B/W,1/30s,30IRE)	0.003Lux/F1.2(Color,1/3s,30IRE) 0.03Lux/F1.2(Color,1/30s,30IRE) 0.001Lux/F1.2(B/W,1/3s,30IRE) 0.01Lux/F1.2(B/W,1/30s,30IRE)	0.01Lux/F1.53(Color,1/3s,30IRE) 0.1Lux/F1.53(Color,1/30s,30IRE) 0Lux/F1.53(IR on)	0.01Lux/F1.53(Color,1/3s,30IRE) 0.1Lux/F1.53(Color,1/30s,30IRE) 0Lux/F1.53(IR on)	0.005Lux/F1.4(Color,1/3s,30IRE) 0.03Lux/F1.4(Color,1/30s,30IRE) 0Lux/F1.4(IR on)	0.002Lux/F1.53(Color,1/3s,30IRE) 0.01Lux/F1.53(Color,1/30s,30IRE) 0Lux/F1.53(IR on)
Day/Night	ICR	ICR	ICR	ICR	ICR	ICR
WDR	120dB	140dB	DWDR	DWDR	140dB	120dB
Max. IR Distance	--	--	50m(164ft)	50m(164ft)	50m(164ft), 100m(328ft)(Z5)	50m(164ft)
Video Compression	H.265+/H.265/H.264+/H.264	H.265+/H.265/H.264+/H.264	H.265+/H.265/H.264+/H.264	H.265+/H.265/H.264+/H.264	H.265+/H.265/H.264+/H.264	H.265+/H.265/H.264+/H.264
Max. Resolution	1080P(1920×1080)	1080P(1920×1080)	12MP(4000×3000)	6MP(3072×2048)	3MP(2048×1536)	1080P(1920×1080)
Frame Rate	60fps@1080P	60fps@1080P	20fps@12MP, 30fps@4K	30fps@6MP	60fps@3MP	60fps@1080P
Multi-streaming	3 streams	3 streams	3 streams	3 streams	3 streams	3 streams
Pan/Tilt/Rotation	--	--	Pan: 0°~360°; Tilt: 0°~90° Rotation: 0°~360°	Pan: 0°~360°; Tilt: 0°~90° Rotation: 0°~360°	Pan: 0°~360°; Tilt: 0°~90° Rotation: 0°~360°	Pan: 0°~360°; Tilt: 0°~90° Rotation: 0°~360°
Intelligent Video	Tripwire, Intrusion Scene Change Abandoned/Missing Face Detection People Counting, Heat Map	Tripwire, Intrusion Scene Change Abandoned/Missing Face Detection People Counting, Heat Map	Tripwire, Intrusion Scene Change Abandoned/Missing Face Detection People Counting, Heat Map	Tripwire, Intrusion Scene Change Abandoned/Missing Face Detection People Counting, Heat Map	Tripwire, Intrusion Scene Change Abandoned/Missing Face Detection People Counting, Heat Map	Tripwire, Intrusion Scene Change Abandoned/Missing Face Detection People Counting, Heat Map
Compatibility	ONVIF profile S&G, API	ONVIF profile S&G, API	ONVIF profile S&G, API	ONVIF profile S&G, API	ONVIF profile S&G, API	ONVIF profile S&G, API
Audio In/Out	2/1, Built-in Mic	2/1, Built-in Mic	1/1	1/1	1/1	1/1
Memory Slot	Micro SD, Max. 128GB	Micro SD, Max. 128GB	Micro SD, Max. 128GB	Micro SD, Max. 128GB	Micro SD, Max. 128GB	Micro SD, Max. 128GB
Alarm In/Out	2 channel In: 5mA 5VDC 2 channel Out: 1A 30VDC/0.5A 50VAC	2 channel In: 5mA 5VDC 2 channel Out: 1A 30VDC/0.5A 50VAC	2 channel In: 5mA 5VDC 1 channel Out: 1A 30VDC/0.5A 50VAC	2 channel In: 5mA 5VDC 1 channel Out: 1A 30VDC/0.5A 50VAC	2 channel In: 5mA 5VDC 1 channel Out: 1A 30VDC/0.5A 50VAC	2 channel In: 5mA 5VDC 1 channel Out: 1A 30VDC/0.5A 50VAC
Ingress Protection	--	--	IP67, IK10	IP67, IK10	IP67, IK10	IP67, IK10
Working Temperature	-30°C~+60°C(-22°F~+140°F)	-30°C~+60°C(-22°F~+140°F)	-40°C~+60°C(-40°F~+140°F)	-40°C~+60°C(-40°F~+140°F)	-40°C~+60°C(-40°F~+140°F)	-40°C~+60°C(-40°F~+140°F)
Power	DC12V/AC24V PoE (802.3af)(Class 0) Max. 6.5W	DC12V/AC24V PoE (802.3af)(Class 0) Max. 5.5W	DC12V PoE+(802.3at)(Class 4) Max. 13W	DC12V PoE+(802.3at)(Class 4) Max. 13W	DC12V PoE+(802.3at)(Class 4) Max. 13W	DC12V PoE+(802.3at)(Class 4) Max. 13W

Ultra-Smart Series

	Vari-Focal Bullet			Vari-Focal Dome		
Model	IPC-HFW8231E-ZE/Z5E	IPC-HDBW81230E-ZE	IPC-HDBW8630E-ZE	IPC-HDBW8331E-ZE/Z5E	IPC-HDBW8232E-ZE	IPC-HDBW8231E-ZE/Z5E
Appearance	 ePoE, Ultra WDR, H.265+, Starlight	 ePoE, 4K, H.265+	 ePoE, H.265+	 ePoE, Ultra WDR, H.265+, Starlight	 ePoE, H.265+, Starlight	 ePoE, Ultra WDR, H.265+, Starlight
Image Sensor	1/2.8" 2MP STARVIS™ CMOS	1/1.7" 12MP STARVIS™ CMOS	1/1.8" 6MP STARVIS™ CMOS	1/2.8" 3MP STARVIS™ CMOS	1/1.9" 2MP Sony CMOS	1/2.8" 2MP STARVIS™ CMOS
Lens	2.7-12mm/F1.4, Motorized 7~35mm/F1.4, Motorized(Z5)	4.1-16.4mm/F1.53(4x Optical zoom)	4.1-16.4mm/F1.53(4x Optical zoom)	2.7~13.5mm/F1.4, Motorized 7~35mm/F1.4, Motorized(Z5)	4.1-16.4mm/F1.53(4x Optical zoom)	2.7-12mm/F1.4, Motorized 7~35mm/F1.4, Motorized(Z5)
FOV-H	114°~36° 34°~11°(Z5)	105°~35°	105°~34°	99°~28° 32°~11°(Z5)	104°~33°	114°~36° 34°~11°(Z5)
Min. Illumination	0.005Lux/F1.4(Color,1/3s,30IRE) 0.03Lux/F1.4(Color,1/30s,30IRE) 0Lux/F1.4(IR on)	0.01Lux/F1.53(Color,1/3s,30IRE) 0.1Lux/F1.53(Color,1/30s,30IRE) 0Lux/F1.53(IR on)	0.01Lux/F1.53(Color,1/3s,30IRE) 0.1Lux/F1.53(Color,1/30s,30IRE) 0Lux/F1.53(IR on)	0.005Lux/F1.4(Color,1/3s,30IRE) 0.03Lux/F1.4(Color,1/30s,30IRE) 0Lux/F1.4(IR on)	0.002Lux/F1.53(Color,1/3s,30IRE) 0.01Lux/F1.53(Color,1/30s,30IRE) 0Lux/F1.53(IR on)	0.005Lux/F1.4(Color,1/3s,30IRE) 0.03Lux/F1.4(Color,1/30s,30IRE) 0Lux/F1.4(IR on)
Day/Night	ICR	ICR	ICR	ICR	ICR	ICR
WDR	140dB	DWDR	DWDR	140dB	120dB	140dB
Max. IR Distance	50m(164ft) 100m(328ft)(Z5)	50m(164ft)	50m(164ft)	50m(164ft) 100m(328ft)(Z5)	50m(164ft)	50m(164ft) 100m(328ft)(Z5)
Video Compression	H.265+/H.265/H.264+/H.264	H.265+/H.265/H.264+/H.264	H.265+/H.265/H.264+/H.264	H.265+/H.265/H.264+/H.264	H.265+/H.265/H.264+/H.264	H.265+/H.265/H.264+/H.264
Max. Resolution	1080P(1920x1080)	12MP(4000x3000)	6MP(3072x2048)	3MP(2048x1536)	1080P(1920x1080)	1080P(1920x1080)
Frame Rate	60fps@1080P	20fps@12MP, 30fps@4K	30fps@6MP	60fps@3MP	60fps@1080P	60fps@1080P
Multi-streaming	3 streams	3 streams	3 streams	3 streams	3 streams	3 streams
Pan/Tilt/Rotation	Pan: 0°~360°; Tilt: 0°~90° Rotation: 0°~360°	Pan: 0°~355°; Tilt: 0°~65° Rotation: 0°~355°	Pan: 0°~355°; Tilt: 0°~65° Rotation: 0°~355°	Pan: 0°~355°; Tilt: 0°~65° Rotation: 0°~355°	Pan: 0°~355°; Tilt: 0°~65° Rotation: 0°~355°	Pan: 0°~355°; Tilt: 0°~65° Rotation: 0°~355°
Intelligent Video	Tripwire, Intrusion Scene Change Abandoned/Missing Face Detection People Counting, Heat Map	Tripwire, Intrusion Scene Change Abandoned/Missing Face Detection People Counting, Heat Map	Tripwire, Intrusion Scene Change Abandoned/Missing Face Detection People Counting, Heat Map	Tripwire, Intrusion Scene Change Abandoned/Missing Face Detection People Counting, Heat Map	Tripwire, Intrusion Scene Change Abandoned/Missing Face Detection People Counting, Heat Map	Tripwire, Intrusion Scene Change Abandoned/Missing Face Detection People Counting, Heat Map
Compatibility	ONVIF profile S&G, API	ONVIF profile S&G, API	ONVIF profile S&G, API	ONVIF profile S&G, API	ONVIF profile S&G, API	ONVIF profile S&G, API
Audio In/Out	1/1	1/1	1/1	1/1	1/1	1/1
Memory Slot	Micro SD, Max. 128GB	Micro SD, Max. 128GB	Micro SD, Max. 128GB	Micro SD, Max. 128GB	Micro SD, Max. 128GB	Micro SD, Max. 128GB
Alarm In/Out	2 channel In: 5mA 5VDC 1 channel Out: 1A 30VDC/0.5A 50VAC	1 channel In: 5mA 5VDC 1 channel Out: 1A 30VDC/0.5A 50VAC	1 channel In: 5mA 5VDC 1 channel Out: 1A 30VDC/0.5A 50VAC	1 channel In: 5mA 5VDC 1 channel Out: 1A 30VDC/0.5A 50VAC	1 channel In: 5mA 5VDC 1 channel Out: 1A 30VDC/0.5A 50VAC	1 channel In: 5mA 5VDC 1 channel Out: 1A 30VDC/0.5A 50VAC
Ingress Protection	IP67, IK10	IP67, IK10	IP67, IK10	IP67, IK10	IP67, IK10	IP67, IK10
Working Temperature	-40°C~-60°C(-40°F~+140°F)	-40°C~-60°C(-40°F~+140°F)	-40°C~-60°C(-40°F~+140°F)	-40°C~-60°C(-40°F~+140°F)	-40°C~-60°C(-40°F~+140°F)	-40°C~-60°C(-40°F~+140°F)
Power	DC12V PoE+(802.3at)(Class 4) Max. 13W	DC12V/AC24V PoE+(802.3at)(Class 4) Max. 18W	DC12V/AC24V PoE+(802.3at)(Class 4) Max. 18W	DC12V/AC24V PoE+(802.3at)(Class 4) Max. 18W	DC12V/AC24V PoE+(802.3at)(Class 4) Max. 18W	DC12V/AC24V PoE+(802.3at)(Class 4) Max. 18W

NETWORK CAMERAS

Panoramic Series

Panoramic Series

The panoramic series is designed for applications which require a 360° or 180° view for situational awareness. With its all-in-one design, the series is a perfect solution to replace multiple conventional cameras, reducing complexity and saving on installation and maintenance costs.

⊕ KEY FEATURES

Sensor Integration

Multiple image sensors on 1 IP address

Eyes All Around

4+1 / 8+1 sensors provide 180°/360° high definition panoramic image



Distortion-Free

Seamless splicing technology produces flawless stitched image

One Replaces Many





Replace multiple cameras, saving on installation & maintenance costs

Panoramic

Model	PSD81602-A360		PSD8802-A180		IPC-PF83230
Appearance					
	H.265+ Starlight		H.265+ Starlight		Starlight
Image Sensor	Panoramic Eight 1/1.9" 2MP Sony CMOS	PTZ 1/1.9" 2MP Sony CMOS	Panoramic Four 1/1.9" 2MP Sony CMOS	PTZ 1/1.9" 2MP Sony CMOS	Four 1/2.0" 8MP CMOS
Lens	5.0mm/F2.2	5.5~206mm/F1.5	5.0mm/F2.2	5.5~206mm/F1.5	4.5mm/F2.4
FOV-H	360°		180°		180°
Min. Illumination	0.005Lux/F2.2(Color,1/3s,30IRE) 0.03Lux/F2.2(Color,1/30s,30IRE) 0.003Lux/F2.2(B/W,1/3s,30IRE) 0.02Lux/F2.2(B/W,1/30s,30IRE)	0.002Lux/F1.5(Color,1/3s,30IRE) 0.01Lux/F1.5(Color,1/30s,30IRE) 0.001Lux/F1.5(B/W,1/3s,30IRE) 0.008Lux/F1.5(B/W,1/30s,30IRE)	0.005Lux/F2.2(Color,1/3s,30IRE) 0.03Lux/F2.2(Color,1/30s,30IRE) 0.003Lux/F2.2(B/W,1/3s,30IRE) 0.02Lux/F2.2(B/W,1/30s,30IRE)	0.002Lux/F1.5(Color,1/3s,30IRE) 0.01Lux/F1.5(Color,1/30s,30IRE) 0.001Lux/F1.5(B/W,1/3s,30IRE) 0.008Lux/F1.5(B/W,1/30s,30IRE)	0.01Lux/F2.4(Color,1/3s,30IRE) 0.1Lux/F2.4(Color,1/30s,30IRE) 0.005Lux/F2.4(B/W,1/3s,30IRE) 0.006Lux/F2.4(B/W,1/30s,30IRE)
Max. IR Distance	--		--		--
Day/Night	--		--		--
WDR	120dB		120dB		DWDR
Video Compression	H.265+/H.265/H.264+/H.264		H.265+/H.265/H.264+/H.264		H.265/H.264
Resolution	2x(4096x1800)	1080P(1920x1080)	4096x1800	1080P(1920x1080)	8640x3840
Frame Rate	25fps@(4096x1800)	60fps@1080P	25fps@(4096x1800)	60fps@1080P	25fps@(8640x3840)
Multi-streaming	3 streams		3 streams		3 streams
Pan/Tilt/Rotation	--	Pan: 0°~360°; Tilt: -20°~90° Auto flip 180°	--	Pan: 0°~360°; Tilt: -20°~90° Auto flip 180°	Pan: 0°~360°; Tilt: 0°~90° Rotation: 0°~355°
Intelligent Video	Tripwire, Intrusion Scene Change	Tripwire, Intrusion Scene Change Abandoned/Missing Face Detection	Tripwire, Intrusion Scene Change	Tripwire, Intrusion Scene Change Abandoned/Missing Face Detection	--
Dewarping Mode	--		--		--
Compatibility	ONVIF profile S&G, API		ONVIF profile S&G, API		ONVIF profile S&G, API
Audio In/Out	2/1		2/1		2/1
Memory Slot	Micro SD, Max. 128GB		Micro SD, Max. 128GB		Micro SD, Max. 128GB
Alarm In/Out	7/2		7/2		2/2
Ingress Protection	IP67, IK10		IP67, IK10		IP67, IK10
Working Temperature	-40°C~-60°C(-40°F~+140°F)		-40°C~-60°C(-40°F~+140°F)		-30°C~-60°C(-22°F~+140°F)
Power	DC36V Max. 120W		DC36V Max. 120W		DC36V Max. 32W

Panoramic Series





Panoramic

Model	IPC-PFW8802-A180	IPC-PFW8800-A180	IPC-PFW8601-A180	IPC-PDBW8802-A180	IPC-PDBW8800-A180
Appearance	 H.265+ Starlight	 H.265+ Starlight	 H.265+ Starlight	 H.265+ Starlight	 H.265+ Starlight
Image Sensor	Four 1/1.9" 2MP Sony CMOS	Four 1/2.8" 2MP STARVIS™ CMOS	Three 1/2.8" 2MP STARVIS™ CMOS	Four 1/1.9" 2MP Sony CMOS	Four 1/2.8" 2MP STARVIS™ CMOS
Lens	5.0mm/F2.2	3.0mm/F2.0	3.6mm/F1.8	5.0mm/F2.2	3.0mm/F2.0
FOV-H	180°	180°	180°	180°	180°
Min. Illumination	0.005Lux/F2.2(Color,1/3s,30IRE) 0.03Lux/F2.2(Color,1/30s,30IRE) 0Lux/F2.2(IR on)	0.007Lux/F2.0(Color,1/3s,30IRE) 0.05Lux/F2.0 (Color,1/30s,30IRE) 0Lux/F2.0(IR on)	0.007Lux/F1.8 (Color,1/3s,30IRE) 0.05Lux/F1.8(Color,1/30s,30IRE) 0Lux/F2.0(IR on)	0.005Lux/F2.2(Color,1/3s,30IRE) 0.03Lux/F2.2(Color,1/30s,30IRE) 0Lux/F2.2(IR on)	0.007Lux/F2.0(Color,1/3s,30IRE) 0.05Lux/F2.0 (Color,1/30s,30IRE) 0Lux/F2.0(IR on)
Max. IR Distance	30m(98ft)	30m(98ft)	30m(98ft)	30m(98ft)	30m(98ft)
Day/Night	ICR	ICR	ICR	ICR	ICR
WDR	120dB	DWDR	120dB	120dB	DWDR
Video Compression	H.265+/H.265 H.264+/H.264	H.265+/H.265 H.264+/H.264	H.265+/H.265 H.264+/H.264	H.265+/H.265 H.264+/H.264	H.265+/H.265 H.264+/H.264
Resolution	4096x1800	4096x1800	4096x832	4096x1800	4096x1800
Frame Rate	25fps@(4096x1800)	25fps@(4096x1800)	30fps@(4096x832)	25fps@(4096x1800)	25fps@(4096x1800)
Multi-streaming	3 streams	3 streams	3 streams	3 streams	3 streams
Pan/Tilt/Rotation	Pan: 0°~360°; Tilt: 0°~90° Rotation: 0°~360°	Pan: 0°~360°; Tilt: 0°~90° Rotation: 0°~360°	Pan: 0°~360°; Tilt: 0°~90° Rotation: 0°~360°	Pan: 0°~360°; Tilt: 0°~90° Rotation: 0°~360°	Pan: 0°~355°; Tilt: 0°~75° Rotation: 0°~±20°
Intelligent Video	Tripwire, Intrusion Scene Change Abandoned/Missing	Tripwire, Intrusion Scene Change Abandoned/Missing	Tripwire, Intrusion Scene Change Abandoned/Missing	Tripwire, Intrusion Scene Change Abandoned/Missing	Tripwire, Intrusion Scene Change Abandoned/Missing
Dewarping Mode	--	--	--	--	--
Compatibility	ONVIF profile S&G, API	ONVIF profile S&G, API	ONVIF profile S&G, API	ONVIF profile S&G, API	ONVIF profile S&G, API
Audio In/Out	1/1	1/1	1/1	1/1	1/1
Memory Slot	Micro SD, Max. 128GB	Micro SD, Max. 128GB	Micro SD, Max. 128GB	Micro SD, Max. 128GB	Micro SD, Max. 128GB
Alarm In/Out	2/2	2/2	2/1	2/2	2/2
Ingress Protection	IP67, IK10	IP67, IK10	IP67, IK10	IP67, IK10	IP67, IK10
Working Temperature	-40°C~+60°C (-40°F~+140°F)	-40°C~+60°C (-40°F~+140°F)	-40°C~+60°C (-40°F~+140°F)	-40°C~+60°C (-40°F~+140°F)	-40°C~+60°C (-40°F~+140°F)
Power	DC12V PoE+ (802.3at)(Class 4) Max. 25.5W	AC24V PoE+ (802.3at)(Class 4) Max. 25.5W	AC24V PoE+ (802.3at)(Class 4) Max. 23W	DC12V PoE+ (802.3at)(Class 4) Max. 25.5W	AC24V PoE+ (802.3at)(Class 4) Max. 25.5W

NETWORK CAMERAS

Panoramic Series

Panoramic

Model	IPC-PDBW5831-B360	IPC-EBW81230	IPC-EBW8630	IPC-EBW8630-IVC	IPC-EB5531
Appearance		 4K H.265+ Starlight	 H.265+ Starlight	 H.265+ Starlight	 H.265+
Image Sensor	Four 1/2.8" 2MP STARVIS™ CMOS	1/1.7" 12MP STARVIS™ CMOS	1/1.8" 6MP STARVIS™ CMOS	1/1.8" 6MP STARVIS™ CMOS	1/2.7" 5M CMOS
Lens	2.7~12mm/F1.4	1.98mm/F2.8	1.7mm/F2.0	1.3mm/F2.8	1.4mm/F1.6
FOV-H	4*(109°~44°)	185°/185°/185°	185°/185°/185°	185°/185°/185°	185°
Min. Illumination	0.006Lux/F1.4(Color,1/3s,30IRE) 0.05Lux/F1.4(Color,1/30s,30IRE) 0Lux/F1.4(IR on)	0.001Lux/F2.8(Color,1/3s,30IRE) 0.01Lux/F2.8(Color,1/30s,30IRE) 0Lux/F2.0(IR on)	0.002Lux/F2.0(Color,1/3s,30IRE) 0.02Lux/F2.0(Color,1/30s,30IRE) 0Lux/F2.0(IR on)	0.005Lux/F2.8(Color,1/3s,30IRE) 0.05Lux/F2.8(Color,1/30s,30IRE) 0Lux/F2.0(IR on)	0.02Lux/F1.6(Color,1/3s,30IRE) 0.2Lux/F1.6(Color,1/30s,30IRE) 0.05Lux/F1.6(B/W,1/3s,30IRE) 0.5Lux/F1.6(B/W,1/30s,30IRE)
Max. IR Distance	30m(98ft)	10m(33ft)	10m(33ft)	10m(33ft)	--
Day/Night	ICR	ICR	ICR	ICR	ICR
WDR	120dB(1 channel)	DWDR	DWDR	DWDR	120dB
Video Compression	H.265+/H.265 H.264+/H.264	H.265+/H.265 H.264+/H.264	H.265+/H.265 H.264+/H.264	H.265+/H.265 H.264+/H.264	H.265+/H.265 H.264+/H.264
Resolution	4*1080P(1920x1080)	12MP(4000x3000)	6MP(3072x2048)	6MP(3072x2048)	5MP(2592x1944)
Frame Rate	30fps@1080P(1920x1080)	25fps@12MP	30fps@6MP	30fps@6MP	20fps@5MP, 30fps@3MP
Multi-streaming	4*2 streams	3 streams	3 streams	3 streams	3 streams
Pan/Tilt/Rotation	Pan: 0°~360°; Tilt: 0°~75° Rotation: 0°~355°	--	--	--	--
Intelligent Video	Tripwire,Intrusion,Scene Change Abandoned/Missing	Tripwire, Intrusion Heat map	Tripwire, Intrusion Heat map	Tripwire, Intrusion Heat map	Tripwire, Intrusion Heat map
Dewarping Mode	--	10; 1P+3R; 2R 10+2R; 10+3R; 4R 10+4R; 1P+6R; 10+8R	10; 1P+3R; 2R 10+2R; 10+3R; 4R 10+4R; 1P+6R; 10+8R	10; 1P+3R; 2R 10+2R; 10+3R; 4R 10+4R; 1P+6R; 10+8R	10; 1P+3R; 2R 10+2R; 10+3R; 4R 10+4R; 1P+6R; 10+8R
Compatibility	ONVIF profile S&G, API	ONVIF profile S&G, API	ONVIF profile S&G, API	ONVIF profile S&G, API	ONVIF profile S&G, API
Audio In/Out	1/1	1/1, Built-in Mic	1/1, Built-in Mic	1/1, Built-in Mic	Built-in Mic
Memory Slot	Micro SD, Max. 128GB	Micro SD, Max. 128GB	Micro SD, Max. 128GB	Micro SD, Max. 128GB	Micro SD, Max. 128GB
Alarm In/Out	1/1	2/2	2/2	2/2	--
Ingress Protection	IP67, IK10	IP67, IK10	IP67, IK10	IP67, IK10	IP67
Working Temperature	-40°C~+60°C (-40°F~+140°F)	-30°C~+60°C (-22°F~+140°F)	-30°C~+60°C (-22°F~+140°F)	-30°C~+60°C (-22°F~+140°F)	-30°C~+60°C (-22°F~+140°F)
Power	AC24V PoE+ (802.3at)(Class 4) Max. 25.5W	DC12V PoE (802.3af)(Class 0) Max. 12W	DC12V PoE (802.3af)(Class 0) Max. 12W	DC12V PoE (802.3af)(Class 0) Max. 12W	DC12V PoE (802.3af)(Class 0) Max. 6W

Pinhole Series

The pinhole series is ideal for ATMs, banks, stores, hotels and offices. It features a modular design with an independent main unit and a miniature sensor unit (with an 8m cable). The series offers the choice of a cylindrical pinhole lens or cylindrical standard lens, which can both be easily installed in any indoor environment.

⊕ KEY FEATURES

Easy Installation

Modular design,
8m cable for covert
installation

Optimized Image

True WDR enables
clear facial image for
accurate identification

Highly Flexible

Multiple sensor
shapes allow flexible
applications

Pinhole Series

Pinhole Camera

Model	IPC-HUM8431-E1	IPC-HUM8431-L1	IPC-HUM8431-L3	IPC-HUM8431-L4	IPC-HUM8431-L5
Appearance	 H.265+	 Starlight			
Image Sensor	--	1/2.7" 4MP CMOS	1/2.7" 4MP CMOS	1/2.7" 4MP CMOS	1/2.7" 4MP CMOS
Lens	--	2.8mm/F2.4	2.8mm/F1.8	2.8mm/F2.4	2.8mm/F2.2
FOV-H	--	H:83°	H:109°	H:83°	H:104°
Min. Illumination	--	0.007Lux/F2.4 (Color,1/3s,30IRE) 0.08Lux/F2.4 (Color,1/30s,30IRE) 0.004Lux/F2.4 (B/W,1/3s,30IRE) 0.04Lux/F2.4 (B/W,1/30s,30IRE)	0.006Lux/F1.8 (Color,1/3s,30IRE) 0.04Lux/F1.8 (Color,1/30s,30IRE) 0.003Lux/F1.8 (B/W,1/3s,30IRE) 0.02Lux/F1.8 (B/W,1/30s,30IRE)	0.007Lux/F2.4 (Color,1/3s,30IRE) 0.08Lux/F2.4 (Color,1/30s,30IRE) 0.004Lux/F2.4 (B/W,1/3s,30IRE) 0.04Lux/F2.4 (B/W,1/30s,30IRE)	0.005Lux/F2.2 (Color,1/3s,30IRE) 0.05Lux/F2.4 (Color,1/30s,30IRE) 0.003Lux/F2.4 (B/W,1/3s,30IRE) 0.03Lux/F2.4 (B/W,1/30s,30IRE)
Day/Night	Electronic	--	--	--	--
WDR	120dB	--	--	--	--
Max. IR Distance	--	--	--	--	--
Video Compression	H.265+/H.265 H.264+/H.264	--	--	--	--
Max. Resolution	4MP(2688×1520)	--	--	--	--
Frame Rate	30fps@4MP	--	--	--	--
Multi-streaming	3 streams	--	--	--	--
Pan/Tilt/Rotation	--	--	--	--	--
Intelligent Video	Tripwire, Intrusion Scene Change Abandoned/Missing Face Detection	--	--	--	--
Compatibility	ONVIF profile S&G, API	--	--	--	--
Audio In/Out	1/1	--	--	--	--
Memory Slot	Micro SD, Max. 128GB	--	--	--	--
Alarm In/Out	2/2	--	--	--	--
Ingress Protection	--	--	--	--	--
Working Temperature	-30°C~+60°C(-22°F~+140°F)	--	--	--	--
Power	DC12V, PoE (802.3af) Max. 6W	--	--	--	--

NETWORK CAMERAS

Pinhole Series

Pinhole Camera

Model	IPC-HUM8231-E2	IPC-HUM8231-E1	IPC-HUM8231-L1	IPC-HUM8231-L3	IPC-HUM8231-L4	IPC-HUM8231-L5	IPC-HUM4231
Appearance		 H.265+					
Image Sensor	--	--	1/2.8" 2MP STARVIS™ CMOS	1/2.8" 2MP STARVIS™ CMOS	1/2.8" 2MP STARVIS™ CMOS	1/2.8" 2MP STARVIS™ CMOS	1/2.7" 2MP CMOS
Lens	--	--	2.8mm/F2.4	2.8mm/F2.4	2.8mm/F2.4	2.8mm/F2.1	2.8mm/F2.4
FOV-H	--	--	H:104°	H:112°	H:103°	H:111°	H:105°
Min. Illumination	--	--	0.02Lux/F2.4 (Color,1/3s,30IRE) 0.08Lux/F2.4 (Color,1/30s,30IRE) 0.01Lux/F2.4 (B/W,1/3s,30IRE) 0.04Lux/F2.4 (B/W,1/30s,30IRE)	0.02Lux/F1.8 (Color,1/3s,30IRE) 0.08Lux/F1.8 (Color,1/30s,30IRE) 0.01Lux/F1.8 (B/W,1/3s,30IRE) 0.04Lux/F1.8 (B/W,1/30s,30IRE)	0.02Lux/F2.4 (Color,1/3s,30IRE) 0.08Lux/F2.4 (Color,1/30s,30IRE) 0.01Lux/F2.4 (B/W,1/3s,30IRE) 0.04Lux/F2.4 (B/W,1/30s,30IRE)	0.02Lux/F2.1 (Color,1/3s,30IRE) 0.08Lux/F2.1 (Color,1/30s,30IRE) 0.01Lux/F2.1 (B/W,1/3s,30IRE) 0.04Lux/F2.1 (B/W,1/30s,30IRE)	0.007Lux/F2.4 (Color,1/3s,30IRE) 0.08Lux/F2.4 (Color,1/30s,30IRE) 0.004Lux/F2.4 (B/W,1/3s,30IRE) 0.04Lux/F2.4 (B/W,1/30s,30IRE)
Day/Night	Electronic	Electronic	--	--	--	--	Electronic
WDR	120dB	120dB	--	--	--	--	120dB
Max. IR Distance	--	--	--	--	--	--	--
Video Compression	H.265/H.264	H.265+/H.265 H.264+/H.264	--	--	--	--	H.265+/H.265 H.264+/H.264
Max. Resolution	1080P(1920×1080)	1080P(1920×1080)	--	--	--	--	1080P(1920×1080)
Frame Rate	2×30fps@1080P	60fps@1080P	--	--	--	--	30fps@1080P
Multi-streaming	2×2 streams	3 streams	--	--	--	--	3 streams
Pan/Tilt/Rotation	--	--	--	--	--	--	--
Intelligent Video	Tripwire, Intrusion Scene Change Abandoned/Missing Face Detection	Tripwire, Intrusion Scene Change Abandoned/Missing Face Detection	--	--	--	--	Tripwire, Intrusion Scene Change Abandoned/Missing Face Detection
Compatibility	ONVIF profile S&G, API	ONVIF profile S&G, API	--	--	--	--	ONVIF profile S&G, API
Audio In/Out	1/1	1/1	--	--	--	--	1/1
Memory Slot	Micro SD, Max. 128GB	Micro SD, Max. 128GB	--	--	--	--	Micro SD, Max. 128GB
Alarm In/Out	2/2	2/2	--	--	--	--	--
Ingress Protection	--	--	--	--	--	--	--
Working Temperature	-30°C~+60°C(-22°F~+140°F)	-30°C~+60°C(-22°F~+140°F)	--	--	--	--	-30°C~+60°C(-22°F~+140°F)
Power	DC12V, PoE (802.3af) Max. 7W	DC12V, PoE (802.3af) Max. 6W	--	--	--	--	DC12V Max. 1.5W

Eco-Savvy 3.0 ePoE Series (Pro Series)

The Eco-Savvy 3.0 is the perfect choice for users who require a great balance of innovation and quality with cost. With ePoE technology for long-range transmission, a wide-range of models, and easy plug & play installation, the Eco-Savvy 3.0 series can meet the needs of diverse applications with challenging conditions.

⊕ KEY FEATURES

Extended PoE

Up to 800m transmission distance @10Mbps & 13W or 300m @100Mbps & 25.4W

Carefree Installation

Automatic setup with plug & play makes installation easy



Wide Selection

Rich selection of IP cameras, NVRs, and network switches

Easy Analog to IP







Migrate analog system to IP with Ethernet-to-coax converter and PoC

Eco-Savvy 3.0 ePoE Series (Pro Series)

	Box Camera		Vari-Focal Bullet	
Model	IPC-HF5431E-E	IPC-HF5231E-E	IPC-HFW5831E-ZE/Z5E	IPC-HFW5631E-ZE/Z5E
Appearance	 ePoE H.265+	 ePoE H.265+ Starlight	 ePoE 4K H.265+	 ePoE H.265+
Image Sensor	1/3" 4MP CMOS	1/2.8" 2MP STARVIS™ CMOS	1/2.5" 8MP STARVIS™ CMOS	1/2.9" 6MP STARVIS™ CMOS
Lens	CS	CS	2.7~12mm/F1.4, Motorized 7~35mm/F1.4, Motorized(Z5)	2.7~13.5mm/F1.4, Motorized 7~35mm/F1.4, Motorized(Z5)
FOV-H	--	--	110°~40° 38°~14°(Z5E)	91°~27° 32°~10°(Z5E)
Min. Illumination	0.02Lux/F1.2(Color,1/3s,30IRE) 0.2Lux/F1.2(Color,1/30s,30IRE) 0.01Lux/F1.2(B/W,1/3s,30IRE) 0.1Lux/F1.2(B/W,1/30s,30IRE)	0.004Lux/F1.2(Color,1/3s,30IRE) 0.04Lux/F1.2(Color,1/30s,30IRE) 0.002Lux/F1.2(B/W,1/3s,30IRE) 0.02Lux/F1.2(B/W,1/30s,30IRE)	0.05Lux/F1.4(Color,1/3s,30IRE) 0.2Lux/F1.4(Color,1/30s,30IRE) 0Lux/F1.4(IR on)	0.03Lux/F1.4(Color,1/3s,30IRE) 0.3Lux/F1.4(Color,1/30s,30IRE) 0Lux/F1.6(IR on)
Day/Night	ICR	ICR	ICR	ICR
WDR	120dB	120dB	120dB	120dB
Max. IR Distance	--	--	50m(164ft) 100m(328ft)(Z5E)	50m(164ft) 100m(328ft)(Z5E)
Video Compression	H.265+/H.265/H.264+/H.264H	H.265+/H.265/H.264+/H.264H	H.265+/H.265/H.264+/H.264H	H.265+/H.265/H.264+/H.264H
Max. Resolution	4MP(2688x1520)	1080P(1920x1080)	4K(3840x2160)	6MP(3072x2048)
Frame Rate	30fps@4MP	60fps@1080P	15fps@4K, 30fps@3MP	20fps@6MP, 30fps@4MP
Multi-streaming	3 streams	3 streams	3 streams	3 streams
Pan/Tilt/Rotation	--	--	Pan: 0°~360°; Tilt: 0°~90° Rotation: 0°~360°	Pan: 0°~360°; Tilt: 0°~90° Rotation: 0°~360°
Intelligent Video	Tripwire, Intrusion Scene Change Abandoned/Missing Face Detection	Tripwire, Intrusion Scene Change Abandoned/Missing Face Detection	Tripwire, Intrusion Scene Change Abandoned/Missing Face Detection	Tripwire, Intrusion Scene Change Abandoned/Missing Face Detection
Compatibility	ONVIF profile S&G, API	ONVIF profile S&G, API	ONVIF profile S&G, API	ONVIF profile S&G, API
Audio In/Out	1/1, Built-in Mic	1/1, Built-in Mic	1/1	1/1
Memory Slot	Micro SD, Max. 128GB	Micro SD, Max. 128GB	Micro SD, Max. 128GB	Micro SD, Max. 128GB
Alarm In/Out	2(5V 5mA)/1(12V 300mA)	2(5V 5mA)/1(12V 300mA)	2(5V 5mA)/1(12V 300mA)	2(5V 5mA)/1(12V 300mA)
Ingress Protection	--	--	IP67, IK10	IP67, IK10
Working Temperature	-30°C~+60°C(-22°F~+140°F)	-30°C~+60°C(-22°F~+140°F)	-30°C~+60°C(-22°F~+140°F)	-30°C~+60°C(-22°F~+140°F)
Power	DC12V/AC24V PoE (802.3af)(Class 0) Max. 8W	DC12V/AC24V PoE (802.3af)(Class 0) Max. 8W	DC12V PoE (802.3af)(Class 0) Max. 12.95W	DC12V PoE (802.3af)(Class 0) Max. 12.95W







NETWORK CAMERAS

Eco-Savvy 3.0 ePoE Series (Pro Series)

	Vari-Focal Bullet		Vari-Focal Dome			
Model	IPC-HFW5431E-ZE/Z5E	IPC-HFW5231E-ZE/Z5E/Z12E	IPC-HDBW5831E-ZE/Z5E	IPC-HDBW5631E-ZE/Z5E	IPC-HDBW5431E-ZE/Z5E	IPC-IPC-HDBW5231E-ZE/Z5E
Appearance	 H.265+	 H.265+ Starlight	 4K H.265+	 H.265+	 H.265+	 H.265+ Starlight
Image Sensor	1/3" 4MP CMOS	1/2.8" 2MP STARVIS™ CMOS	1/2.5" 8MP STARVIS™ CMOS	1/2.9" 6MP STARVIS™ CMOS	1/3" 4MP CMOS	1/2.8" 2MP STARVIS™ CMOS
Lens	2.7~13.5mm/F1.4, Motorized 7~35mm/F1.4, Motorized(Z5E)	2.7~13.5mm/F1.4, Motorized 7~35mm/F1.4, Motorized(Z5E) 5.3~64mm/F1.4, Motorized(Z12E)	2.7~12mm/F1.4, Motorized 7~35mm/F1.4, Motorized(Z5E)	2.7~13.5mm/F1.4, Motorized 7~35mm/F1.4, Motorized(Z5E)	2.7~13.5mm/F1.4, Motorized 7~35mm/F1.4, Motorized(Z5E)	2.7~13.5mm/F1.4, Motorized 7~35mm/F1.4, Motorized(Z5E)
FOV-H	106°~31° 33°~12°(Z5E)	101°~31° 35°~12°(Z5E) 59°~5°(Z12E)	110°~40° 38°~14°(Z5E)	91°~27° 32°~10°(Z5E)	106°~31° 33°~12°(Z5E)	101°~31° 35°~12°(Z5E)
Min. Illumination	0.03Lux/F1.4(Color,1/3s,30IRE) 0.3Lux/F1.4(Color,1/30s,30IRE) 0Lux/F1.4(IR on)	0.006Lux/F1.4(Color,1/3s,30IRE) 0.05Lux/F1.4(Color,1/30s,30IRE) 0Lux/F1.4(IR on)	0.05Lux/F1.4(Color,1/3s,30IRE) 0.2Lux/F1.4(Color,1/30s,30IRE) 0Lux/F1.4(IR on)	0.03Lux/F1.4(Color,1/3s,30IRE) 0.3Lux/F1.4(Color,1/30s,30IRE) 0Lux/F1.6(IR on)	0.03Lux/F1.4(Color,1/3s,30IRE) 0.3Lux/F1.4(Color,1/30s,30IRE) 0Lux/F1.4(IR on)	0.006Lux/F1.4(Color,1/3s,30IRE) 0.05Lux/F1.4(Color,1/30s,30IRE) 0Lux/F1.4(IR on)
Day/Night	ICR	ICR	ICR	ICR	ICR	ICR
WDR	120dB	120dB	120dB	120dB	120dB	120dB
Max. IR Distance	50m(164ft) 100m(328ft)(Z5E)	50m(164ft) 100m(328ft)(Z5E) 200m(656ft)(Z12E)	50m(164ft) 100m(328ft)(Z5E)	50m(164ft) 100m(328ft)(Z5E)	50m(164ft) 100m(328ft)(Z5E)	50m(164ft) 100m(328ft)(Z5E)
Video Compression	H.265+/H.265/H.264+/H.264H	H.265+/H.265/H.264+/H.264H	H.265+/H.265/H.264+/H.264H	H.265+/H.265/H.264+/H.264H	H.265+/H.265/H.264+/H.264H	H.265+/H.265/H.264+/H.264H
Max. Resolution	4MP(2688x1520)	1080P(1920x1080)	4K(3840x2160)	6MP(3072x2048)	4MP(2688x1520)	1080P(1920x1080)
Frame Rate	30fps@4MP	60fps@1080P	15fps@4K, 30fps@3MP	20fps@6MP, 30fps@4MP	30fps@4MP	60fps@1080P
Multi-streaming	3 streams	3 streams	3 streams	3 streams	3 streams	3 streams
Pan/Tilt/Rotation	Pan: 0°~360°; Tilt: 0°~90° Rotation: 0°~360°	Pan: 0°~360°; Tilt: 0°~90° Rotation: 0°~360°	Pan: 0°~355°; Tilt: 0°~65° Rotation: 0°~355°	Pan: 0°~355°; Tilt: 0°~65° Rotation: 0°~355°	Pan: 0°~355°; Tilt: 0°~65° Rotation: 0°~355°	Pan: 0°~355°; Tilt: 0°~65° Rotation: 0°~355°
Intelligent Video	Tripwire, Intrusion Scene Change Abandoned/Missing Face Detection	Tripwire, Intrusion Scene Change Abandoned/Missing Face Detection	Tripwire, Intrusion Scene Change Abandoned/Missing Face Detection	Tripwire, Intrusion Scene Change Abandoned/Missing Face Detection	Tripwire, Intrusion Scene Change Abandoned/Missing Face Detection	Tripwire, Intrusion Scene Change Abandoned/Missing Face Detection
Compatibility	ONVIF profile S&G, API	ONVIF profile S&G, API	ONVIF profile S&G, API	ONVIF profile S&G, API	ONVIF profile S&G, API	ONVIF profile S&G, API
Audio In/Out	1/1	1/1	1/1	1/1	1/1	1/1
Memory Slot	Micro SD, Max. 128GB	Micro SD, Max. 128GB	Micro SD, Max. 128GB	Micro SD, Max. 128GB	Micro SD, Max. 128GB	Micro SD, Max. 128GB
Alarm In/Out	2(5V 5mA)/1(12V 300mA)	2(5V 5mA)/1(12V 300mA)	1(5V 5mA)/1(12V 300mA)	1(5V 5mA)/1(12V 300mA)	1(5V 5mA)/1(12V 300mA)	1(5V 5mA)/1(12V 300mA)
Ingress Protection	IP67, IK10	IP67, IK10	IP67, IK10	IP67, IK10	IP67, IK10	IP67, IK10
Working Temperature	-30°C~-60°C(-22°F~+140°F)	-30°C~-60°C(-22°F~+140°F)	-30°C~-60°C(-22°F~+140°F)	-30°C~-60°C(-22°F~+140°F)	-30°C~-60°C(-22°F~+140°F)	-30°C~-60°C(-22°F~+140°F)
Power	DC12V PoE (802.3af)(Class 0) Max. 12.95W	DC12V PoE (802.3af)(Class 0) Max. 12.95W	DC12V/AC24V PoE+(802.3at)(Class 4) Max. 14.5W	DC12V/AC24V PoE+ (802.3at)(Class 4) Max. 14.5W	DC12V/AC24V PoE+(802.3at)(Class 4) Max. 13.5W	DC12V/AC24V PoE+(802.3at)(Class 4) Max. 13.5W







Eco-Savvy 3.0 ePoE Series (Pro Series)

Fixed Mini-Bullet









Model	IPC-HFW4831E-SE	IPC-HFW4631E-SE	IPC-HFW4431E-SE	IPC-HFW4231E-SE	IPC-HFW4831T-ASE	IPC-HFW4631T-ASE	IPC-HFW4431T-ASE
Appearance	 4K H.265+	 H.265+	 H.265+	 H.265+ Starlight	 4K H.265+	 H.265+	 H.265+
Image Sensor	1/2.5" 8MP STARVIS™ CMOS	1/2.9" 6MP STARVIS™ CMOS	1/3" 4MP CMOS	1/2.8" 2MP STARVIS™ CMOS	1/2.5" 8MP STARVIS™ CMOS	1/2.9" 6MP STARVIS™ CMOS	1/3" 4MP CMOS
Lens	2.8mm/F1.6, 4mm/F1.6	2.8mm/F1.6, 3.6mm/F1.6	3.6mm/F1.6, 6mm/F1.6	3.6mm/F1.6, 6mm/F1.6	2.8mm/F1.6, 4mm/F1.6	3.6mm/F1.6, 6mm/F1.6	3.6mm/F1.6, 6mm/F1.6 8mm/F1.6, 12mm/F1.6
FOV-H	112°/88°	98°/69°	87°/55°	87°/51°	112°/88°	98°/69°	87°/55°/38°/25°
Min. Illumination	0.06Lux/F1.6(Color,1/3s,30IRE) 0.3Lux/F1.6(Color,1/30s,30IRE) 0Lux/F1.6(IR on)	0.04Lux/F1.6(Color,1/3s,30IRE) 0.4Lux/F1.6(Color,1/30s,30IRE) 0Lux/F1.6(IR on)	0.06Lux/F1.6(Color,1/3s,30IRE) 0.4Lux/F1.6(Color,1/30s,30IRE) 0Lux/F1.6(IR on)	0.007Lux/F1.6(Color,1/3s,30IRE) 0.06Lux/F1.6(Color,1/30s,30IRE) 0Lux/F1.6(IR on)	0.06Lux/F1.6(Color,1/3s,30IRE) 0.3Lux/F1.6(Color,1/30s,30IRE) 0Lux/F1.6(IR on)	0.04Lux/F1.6(Color,1/3s,30IRE) 0.4Lux/F1.6(Color,1/30s,30IRE) 0Lux/F1.6(IR on)	0.06Lux/F1.6(Color,1/3s,30IRE) 0.4Lux/F1.6(Color,1/30s,30IRE) 0Lux/F1.6(IR on)
Day/Night	ICR	ICR	ICR	ICR	ICR	ICR	ICR
WDR	120dB	120dB	120dB	120dB	120dB	120dB	120dB
Max. IR Distance	40m(131.2ft)	40m(131.2ft)	40m(131.2ft)	40m(131.2ft)	80m(262ft)	80m(262ft)	80m(262ft)
Video Compression	H.265+/H.265/H.264+/H.264H	H.265+/H.265/H.264+/H.264H	H.265+/H.265/H.264+/H.264H	H.265+/H.265/H.264+/H.264H	H.265+/H.265/H.264+/H.264H	H.265+/H.265/H.264+/H.264H	H.265+/H.265/H.264+/H.264H
Max. Resolution	4K(3840x2160)	6MP(3072x2048)	4MP(2688x1520)	1080P(1920x1080)	4K(3840x2160)	6MP(3072x2048)	4MP(2688x1520)
Frame Rate	15fps@4K, 30fps@3MP	20fps@6MP, 30fps@4MP	30fps@4MP	60fps@1080P	15fps@4K, 30fps@3MP	20fps@6MP, 30fps@4MP	30fps@4MP
Multi-streaming	3 streams	3 streams	3 streams	3 streams	3 streams	3 streams	3 streams
Pan/Tilt/Rotation	Pan: 0°~360°; Tilt: 0°~90° Rotation: 0°~360°	Pan: 0°~360°; Tilt: 0°~90° Rotation: 0°~360°	Pan: 0°~360°; Tilt: 0°~90° Rotation: 0°~360°	Pan: 0°~360°; Tilt: 0°~90° Rotation: 0°~360°	Pan: 0°~360°; Tilt: 0°~87° Rotation: 0°~360°	Pan: 0°~360°; Tilt: 0°~87° Rotation: 0°~360°	Pan: 0°~360°; Tilt: 0°~87° Rotation: 0°~360°
Intelligent Video	Tripwire, Intrusion Scene Change Abandoned/Missing Face Detection	Tripwire, Intrusion Scene Change Abandoned/Missing Face Detection	Tripwire, Intrusion Scene Change Abandoned/Missing Face Detection	Tripwire, Intrusion Scene Change Abandoned/Missing Face Detection	Tripwire, Intrusion Scene Change Abandoned/Missing Face Detection	Tripwire, Intrusion Scene Change Abandoned/Missing Face Detection	Tripwire, Intrusion Scene Change Abandoned/Missing Face Detection
Compatibility	ONVIF profile S&G, API	ONVIF profile S&G, API	ONVIF profile S&G, API	ONVIF profile S&G, API	ONVIF profile S&G, API	ONVIF profile S&G, API	ONVIF profile S&G, API
Audio In/Out	--	--	--	--	1/1	1/1	1/1
Memory Slot	Micro SD, Max. 128GB	Micro SD, Max. 128GB	Micro SD, Max. 128GB	Micro SD, Max. 128GB	Micro SD, Max. 128GB	Micro SD, Max. 128GB	Micro SD, Max. 128GB
Alarm In/Out	--	--	--	--	1(5V 5mA)/1(12V 300mA)	1(5V 5mA)/1(12V 300mA)	1(5V 5mA)/1(12V 300mA)
Ingress Protection	IP67	IP67	IP67	IP67	IP67, IK10	IP67, IK10	IP67, IK10
Working Temperature	-30°C~+60°C(-22°F~+140°F)	-30°C~+60°C(-22°F~+140°F)	-30°C~+60°C(-22°F~+140°F)	-30°C~+60°C(-22°F~+140°F)	-30°C~+60°C(-22°F~+140°F)	-30°C~+60°C(-22°F~+140°F)	-30°C~+60°C(-22°F~+140°F)
Power	DC12V, PoE (802.3af) Max. 8.5W	DC12V, PoE (802.3af) Max. 8.5W	DC12V, PoE (802.3af) Max. 8W	DC12V, PoE (802.3af) Max. 8W	DC12V, PoE (802.3af) Max. 12.9W	DC12V, PoE (802.3af) Max. 12.9W	DC12V, PoE (802.3af) Max. 12W

NETWORK CAMERAS

Eco-Savvy 3.0 ePoE Series (Pro Series)

	Fixed Mini-Bullet	Fixed Mini-Dome				Wedge Dome	
Model	IPC-HFW4231T-ASE	IPC-HDBW4831E-ASE	IPC-HDBW4631E-ASE	IPC-HDBW4431E-ASE	IPC-HDBW4231E-ASE	IPC-HDBW4431F-AS	IPC-HDBW4231F-AS
Appearance	 ePoE H.265+ Starlight	 ePoE 4K H.265+	 ePoE H.265+	 ePoE H.265+	 ePoE H.265+ Starlight	 H.265+	 H.265+ Starlight
Image Sensor	1/2.8" 2MP STARVIS™ CMOS	1/2.5" 8MP STARVIS™ CMOS	1/2.9" 6MP STARVIS™ CMOS	1/3" 4MP CMOS	1/2.8" 2MP STARVIS™ CMOS	1/3" 4MP CMOS	1/2.8" 2MP STARVIS™ CMOS
Lens	3.6mm/F1.6, 6mm/F1.6 8mm/F1.6, 12mm/F1.6	2.8mm/F1.6 4mm/F1.6	2.8mm/F1.6 3.6mm/F1.6	2.8mm/F1.6 3.6mm/F1.6 6mm/F1.6	2.8mm/F1.6 3.6mm/F1.6 6mm/F1.6	2.8mm/F2.0 3.6mm/F2.0 6mm/F2.0	2.8mm/F2.0 3.6mm/F2.0 6mm/F2.0
FOV-H	87°/51°/41°/26°	125°/88°	98°/69°	104°/87°/55°	110°/87°/51°	104°/87°/55°	110°/87°/51°
Min. Illumination	0.007Lux/F1.6(Color,1/3s,30IRE) 0.06Lux/F1.6(Color,1/30s,30IRE) 0Lux/F1.6(IR on)	0.06Lux/F1.6(Color,1/3s,30IRE) 0.3Lux/F1.6(Color,1/30s,30IRE) 0Lux/F1.6(IR on)	0.04Lux/F1.6(Color,1/3s,30IRE) 0.4Lux/F1.6(Color,1/30s,30IRE) 0Lux/F1.6(IR on)	0.06Lux/F1.6(Color,1/3s,30IRE) 0.4Lux/F1.6(Color,1/30s,30IRE) 0Lux/F1.6(IR on)	0.007Lux/F1.6(Color,1/3s,30IRE) 0.06Lux/F1.6(Color,1/30s,30IRE) 0Lux/F1.6(IR on)	0.08Lux/F2.0(Color,1/3s,30IRE) 0.3Lux/F2.0(Color,1/30s,30IRE) 0Lux/F2.0(IR on)	0.009Lux/F2.0(Color,1/3s,30IRE) 0.07Lux/F2.0(Color,1/30s,30IRE) 0Lux/F2.0(IR on)
Day/Night	ICR	ICR	ICR	ICR	ICR	ICR	ICR
WDR	120dB	120dB	120dB	120dB	120dB	120dB	120dB
Max. IR Distance	80m(262ft)	30m(98ft)	30m(98ft)	30m(98ft)	30m(98ft)	20m(66ft)	20m(66ft)
Video Compression	H.265+/H.265 H.264+/H.264H	H.265+/H.265 H.264+/H.264H	H.265+/H.265 H.264+/H.264H	H.265+/H.265 H.264+/H.264H	H.265+/H.265 H.264+/H.264H	H.265+/H.265 H.264+/H.264H	H.265+/H.265 H.264+/H.264H
Max. Resolution	1080P(1920×1080)	4K(3840×2160)	6MP(3072×2048)	4MP(2688×1520)	1080P(1920×1080)	4MP(2688×1520)	1080P(1920×1080)
Frame Rate	60fps@1080P	15fps@4K, 30fps@3MP	20fps@6MP, 30fps@4MP	30fps@4MP	60fps@1080P	30fps@4MP	60fps@1080P
Multi-streaming	3 streams	3 streams	3 streams	3 streams	3 streams	3 streams	3 streams
Pan/Tilt/Rotation	Pan: 0°~360°; Tilt: 0°~87° Rotation: 0°~360°	Pan: 0°~355°; Tilt: 0°~65° Rotation: 0°~355°	Pan: 0°~355°; Tilt: 0°~65° Rotation: 0°~355°	Pan: 0°~355°; Tilt: 0°~65° Rotation: 0°~355°	Pan: 0°~355°; Tilt: 0°~65° Rotation: 0°~355°	Pan: 0°~60°; Tilt: 0°~80° Rotation: 0°~360°	Pan: 0°~60°; Tilt: 0°~80° Rotation: 0°~360°
Intelligent Video	Tripwire, Intrusion Scene Change Abandoned/Missing Face Detection	Tripwire, Intrusion Scene Change Abandoned/Missing Face Detection	Tripwire, Intrusion Scene Change Abandoned/Missing Face Detection	Tripwire, Intrusion Scene Change Abandoned/Missing Face Detection	Tripwire, Intrusion Scene Change Abandoned/Missing Face Detection	Tripwire, Intrusion Scene Change Abandoned/Missing Face Detection	Tripwire, Intrusion Scene Change Abandoned/Missing Face Detection
Compatibility	ONVIF profile S&G, API	ONVIF profile S&G, API	ONVIF profile S&G, API	ONVIF profile S&G, API	ONVIF profile S&G, API	ONVIF profile S&G, API	ONVIF profile S&G, API
Audio In/Out	1/1	1/1	1/1	1/1	1/1	Built-in Mic	Built-in Mic
Memory Slot	Micro SD, Max. 128GB	Micro SD, Max. 128GB	Micro SD, Max. 128GB	Micro SD, Max. 128GB	Micro SD, Max. 128GB	Micro SD, Max. 128GB	Micro SD, Max. 128GB
Alarm In/Out	1(5V 5mA)/1(12V 300mA)	1(5V 5mA)/1(12V 300mA)	1(5V 5mA)/1(12V 300mA)	1(5V 5mA)/1(12V 300mA)	1(5V 5mA)/1(12V 300mA)	--	--
Ingress Protection	IP67, IK10	IP67, IK10	IP67, IK10	IP67, IK10	IP67, IK10	IP67, IK10	IP67, IK10
Working Temperature	-30°C~+60°C(-22°F~+140°F)	-30°C~+60°C(-22°F~+140°F)	-30°C~+60°C(-22°F~+140°F)	-30°C~+60°C(-22°F~+140°F)	-30°C~+60°C(-22°F~+140°F)	-30°C~+60°C(-22°F~+140°F)	-30°C~+60°C(-22°F~+140°F)
Power	DC12V, PoE (802.3af)(Class 0) Max. 12W	DC12V, PoE (802.3af)(Class 0) Max. 7.5W	DC12V, PoE (802.3af)(Class 0) Max. 7.5W	DC12V, PoE (802.3af)(Class 0) Max. 7W	DC12V, PoE (802.3af)(Class 0) Max. 7W	DC12V, PoE (802.3af)(Class 0) Max. 6W	DC12V, PoE (802.3af)(Class 0) Max. 6W

Eco-Savvy 3.0 ePoE Series (Pro Series)

	Fixed Mini-Dome		Recessed Mount Dome		Fixed Eyeball			
Model	IPC-HDB4431C-AS	IPC-HDB4231C-AS	IPC-HDB4431G-AS	IPC-HDB4231G-AS	IPC-HDW4831EM-ASE	IPC-HDW4631EM-ASE	IPC-HDW4431EM-ASE	IPC-HDW4231EM-ASE
Appearance	 H.265+	 H.265+ Starlight	 H.265+	 H.265+ Starlight	 4K H.265+ ePoE	 H.265+ ePoE	 H.265+ ePoE	 H.265+ Starlight ePoE
Image Sensor	1/3" 4MP CMOS	1/2.8" 2MP STARVIS™ CMOS	1/3" 4MP CMOS	1/2.8" 2MP STARVIS™ CMOS	1/2.5" 8MP STARVIS™ CMOS	1/2.9" 6MP STARVIS™ CMOS	1/3" 4MP CMOS	1/2.8" 2MP STARVIS™ CMOS
Lens	2.8mm/F2.0 3.6mm/F2.0	2.8mm/F2.0 3.6mm/F2.0	2.8mm/F2.0 3.6mm/F2.0	2.8mm/F2.0 3.6mm/F2.0	2.8mm/F1.6 4mm/F1.6	2.8mm/F1.6 3.6mm/F1.6	2.8mm/F1.6 3.6mm/F1.6 6mm/F1.6	2.8mm/F1.6 3.6mm/F1.6 6mm/F1.6
FOV-H	104°/87°	110°/87°	104°/87°	110°/87°	112°/88°	98°/69°	104°/87°/55°	110°/87°/51°
Min. Illumination	0.08Lux/F2.0(Color,1/3s,30IRE) 0.3Lux/F2.0(Color,1/30s,30IRE) 0.04Lux/F2.0(B/W,1/3s,30IRE) 0.2Lux/2.0(B/W,1/30s,30IRE)	0.009Lux/F2.0(Color,1/3s,30IRE) 0.07Lux/F2.0(Color,1/30s,30IRE) 0.005Lux/F2.0(B/W,1/3s,30IRE) 0.03Lux/2.0(B/W,1/30s,30IRE)	0.08Lux/F2.0(Color,1/3s,30IRE) 0.3Lux/F2.0(Color,1/30s,30IRE) 0.04Lux/F2.0(B/W,1/3s,30IRE) 0.2Lux/2.0(B/W,1/30s,30IRE)	0.009Lux/F2.0(Color,1/3s,30IRE) 0.07Lux/F2.0(Color,1/30s,30IRE) 0.005Lux/F2.0(B/W,1/3s,30IRE) 0.03Lux/2.0(B/W,1/30s,30IRE)	0.06Lux/F1.6(Color,1/3s,30IRE) 0.3Lux/F1.6(Color,1/30s,30IRE) 0Lux/F1.6(IR on)	0.04Lux/F1.6(Color,1/3s,30IRE) 0.4Lux/F1.6(Color,1/30s,30IRE) 0Lux/F1.6(IR on)	0.06Lux/F1.6(Color,1/3s,30IRE) 0.4Lux/F1.6 (Color,1/30s,30IRE) 0Lux/F1.6(IR on)	0.007Lux/F1.6(Color,1/3s,30IRE) 0.06Lux/F1.6 (Color,1/30s,30IRE) 0Lux/F1.6(IR on)
Day/Night	Electronic	Electronic	Electronic	Electronic	ICR	ICR	ICR	ICR
WDR	120dB	120dB	120dB	120dB	120dB	120dB	120dB	120dB
Max. IR Distance	--	--	--	--	50m(164ft)	50m(164ft)	50m(164ft)	50m(164ft)
Video Compression	H.265+/H.265 H.264+/H.264H	H.265+/H.265 H.264+/H.264H	H.265+/H.265 H.264+/H.264H	H.265+/H.265 H.264+/H.264H	H.265+/H.265 H.264+/H.264H	H.265+/H.265 H.264+/H.264H	H.265+/H.265 H.264+/H.264H	H.265+/H.265 H.264+/H.264H
Max. Resolution	4MP(2688×1520)	1080P(1920×1080)	4MP(2688×1520)	1080P(1920×1080)	4K(3840×2160)	6MP(3072×2048)	4MP(2668×1520)	1080P(1920×1080)
Frame Rate	30fps@4MP	60fps@1080P	30fps@4MP	60fps@1080P	15fps@4K,30fps@3MP	20fps@6MP, 30fps@4MP	30fps@4MP	60fps@1080P
Multi-streaming	3 streams	3 streams	3 streams	3 streams	3 streams	3 streams	3 streams	3 streams
Pan/Tilt/Rotation	Pan: 0°~355°; Tilt: 0°~75° Rotation: 0°~360°	Pan: 0°~355°; Tilt: 0°~75° Rotation: 0°~360°	Pan: 0°~360°; Tilt: 0°~90° Rotation: 0°~360°	Pan: 0°~360°; Tilt: 0°~90° Rotation: 0°~360°	Pan: 0°~360°; Tilt: 0°~78° Rotation: 0°~360°	Pan: 0°~360°; Tilt: 0°~78° Rotation: 0°~360°	Pan: 0°~360°; Tilt: 0°~78° Rotation: 0°~360°	Pan: 0°~360°; Tilt: 0°~78° Rotation: 0°~360°
Intelligent Video	Tripwire, Intrusion Scene Change Abandoned/Missing Face Detection	Tripwire, Intrusion Scene Change Abandoned/Missing Face Detection	Tripwire, Intrusion Scene Change Abandoned/Missing Face Detection	Tripwire, Intrusion Scene Change Abandoned/Missing Face Detection	Tripwire, Intrusion Scene Change Abandoned/Missing Face Detection	Tripwire, Intrusion Scene Change Abandoned/Missing Face Detection	Tripwire, Intrusion Scene Change Abandoned/Missing Face Detection	Tripwire, Intrusion Scene Change Abandoned/Missing Face Detection
Compatibility	ONVIF profile S&G, API	ONVIF profile S&G, API	ONVIF profile S&G, API	ONVIF profile S&G, API	ONVIF profile S&G, API	ONVIF profile S&G, API	ONVIF profile S&G, API	ONVIF profile S&G, API
Audio In/Out	Built-in Mic	Built-in Mic	Built-in Mic	Built-in Mic	Built-in Mic	Built-in Mic	Built-in Mic	Built-in Mic
Memory Slot	Micro SD, Max. 128GB	Micro SD, Max. 128GB	Micro SD, Max. 128GB	Micro SD, Max. 128GB	Micro SD, Max. 128GB	Micro SD, Max. 128GB	Micro SD, Max. 128GB	Micro SD, Max. 128GB
Alarm In/Out	--	--	--	--	--	--	--	--
Ingress Protection	IP67	IP67	IK08	IK08	IP67	IP67	IP67	IP67
Working Temperature	-30°C~-60°C(-22°F~+140°F)	-30°C~-60°C(-22°F~+140°F)	-10°C~+45°C(+14°F~+113°F)	-10°C~+45°C(+14°F~+113°F)	-30°C~-60°C(-22°F~+140°F)	-30°C~-60°C(-22°F~+140°F)	-30°C~-60°C(-22°F~+140°F)	-30°C~-60°C(-22°F~+140°F)
Power	DC12V PoE (802.3af)(Class 0) Max. 4.5W	DC12V PoE (802.3af)(Class 0) Max. 4.5W	DC12V PoE (802.3af) Max. 4.5W	DC12V PoE (802.3af) Max. 4.5W	DC12V PoE (802.3af)(Class 0) Max. 7.5W	DC12V PoE (802.3af) Max. 7.5W	DC12V PoE (802.3af)(Class 0) Max. 7W	DC12V PoE (802.3af)(Class 0) Max. 7W

NETWORK CAMERAS

Lite 2.0 Series

Lite 2.0 Series

The Lite Series is suitable for users who want quality but have tight budget constraints. Superior cost/performance, easy installation, and Dahua quality standards and assurance make it a good choice for residential and small-medium business applications.

⊕ KEY FEATURES

H.265+

Advanced encoding saves up to 70% bandwidth and storage

Easy & Reliable

Simple setup and high quality cameras for stable surveillance

Cost-Effective

Performance and quality are combined at an affordable price



Vari-Focal Bullet

Model	IPC-HFW2831T-ZS	IPC-HFW2531T-VFS/ZS	IPC-HFW2431T-VFS/ZS	IPC-HFW2231T-VFS/ZS
Appearance	 H.265+	 H.265+	 H.265+	 H.265+ Starlight
Image Sensor	1/2" 8MP CMOS	1/2.7" 5MP CMOS	1/3" 4MP CMOS	1/2.8" 2MP STARVIS™ CMOS
Lens	3.7~11mm/F1.9	2.7~13.5mm/F1.4 Manual(-VFS) Motorized(-ZS)	2.7~13.5mm/F1.4 Manual(-VFS) Motorized(-ZS)	2.7~13.5mm/F1.4 Manual(-VFS) Motorized(-ZS)
FOV-H	112°~46°	95°~27°	104°~28°	106°~29°
Min. Illumination	0.004Lux/F1.9(Color,1/3s,30IRE) 0.09Lux/F1.9 (Color,1/30s,30IRE) 0Lux/F1.9(IR on)	0.02Lux/F1.4(Color,1/3s,30IRE) 0.2Lux/F1.4(Color,1/30s,30IRE) 0Lux/F1.4(IR on)	0.03Lux/F1.4(Color,1/3s,30IRE) 0.3Lux/F1.4(Color,1/30s,30IRE) 0Lux/F1.4(IR on)	0.006Lux/F1.4(Color,1/3s,30IRE) 0.05Lux/F1.4(Color,1/30s,30IRE) 0Lux/F1.4(IR on)
Day/Night	ICR	ICR	ICR	ICR
WDR	120dB	120dB	120dB	120dB
Max. IR Distance	60m(197ft)	60m(197ft)	60m(197ft)	60m(197ft)
Video Compression	H.265+/H.265 H.264+/H.264H	H.265+/H.265 H.264+/H.264H	H.265+/H.265 H.264+/H.264H	H.265+/H.265 H.264+/H.264H
Max. Resolution	8M(3840x2160)	5MP(2592x1944)	4MP(2688x1520)	1080P(1920x1080)
Frame Rate	30fps@8MP	15fps@5MP 30fps@3MP	20fps@4MP 30fps@3MP	30fps@1080P
Multi-streaming	2 streams	2 streams	2 streams	2 streams
Pan/Tilt/Rotation	Pan: 0°~360° Tilt: 0°~80° Rotation: 0°~360°	Pan: 0°~360°; Tilt: 0°~90° Rotation: 0°~360°	Pan: 0°~360°; Tilt: 0°~90° Rotation: 0°~360°	Pan: 0°~360°; Tilt: 0°~90° Rotation: 0°~360°
Intelligent Video	Tripwire, Intrusion	Tripwire, Intrusion	Tripwire, Intrusion	Tripwire, Intrusion
Compatibility	ONVIF profile S&G, API	ONVIF profile S&G, API	ONVIF profile S&G, API	ONVIF profile S&G, API
Audio In/Out	--	--	--	--
Memory Slot	Micro SD, Max. 128GB	Micro SD, Max. 128GB	Micro SD, Max. 128GB	Micro SD, Max. 128GB
Alarm In/Out	--	--	--	--
Ingress Protection	IP67	IP67	IP67	IP67
Working Temperature	-30°C~+60°C(-22°F~+140°F)	-30°C~+60°C(-22°F~+140°F)	-30°C~+60°C(-22°F~+140°F)	-30°C~+60°C(-22°F~+140°F)
Power	DC12V PoE (802.3af)(Class 0) Max. 11.2W	DC12V PoE (802.3af)(Class 0) Max. 12.7W(-ZS), 11.4W(-VFS)	DC12V PoE (802.3af)(Class 0) Max. 12.5W(-ZS), 11.2W(-VFS)	DC12V PoE (802.3af)(Class 0) Max. 12.1W(-ZS), 10.8W(-VFS)

NETWORK CAMERAS





Lite 2.0 Series

Vari-Focal Dome







Model	IPC-HDBW2831R-ZS	IPC-HDBW2531R-VFS/ZS	IPC-HDBW2431R-VFS/ZS	IPC-HDBW2231R-VFS/ZS
Appearance	 H.265+	 H.265+	 H.265+ Starlight	 H.265+
Image Sensor	1/2" 8MP CMOS	1/2.7" 5MP CMOS	1/3" 4MP CMOS	1/2.8" 2MP STARVIS™ CMOS
Lens	3.7~11mm/F1.9	2.7~13.5mm/F1.4 Manual(-VFS), Motorized(-ZS)	2.7~13.5mm/F1.4 Manual(-VFS), Motorized(-ZS)	2.7~13.5mm/F1.4 Manual(-VFS), Motorized(-ZS)
FOV-H	112°~46°	95°~27°	104°~28°	106°~29°
Min. Illumination	0.004Lux/F1.9(Color,1/3s,30IRE) 0.09Lux/F1.9 (Color,1/30s,30IRE) 0Lux/F1.9(IR on)	0.02Lux/F1.4(Color,1/3s,30IRE) 0.2Lux/F1.4(Color,1/30s,30IRE) 0Lux/F1.4(IR on)	0.03Lux/F1.4(Color,1/3s,30IRE) 0.3Lux/F1.4(Color,1/30s,30IRE) 0Lux/F1.4(IR on)	0.006Lux/F1.4(Color,1/3s,30IRE) 0.05Lux/F1.4(Color,1/30s,30IRE) 0Lux/F1.4(IR on)
Day/Night	ICR	ICR	ICR	ICR
WDR	120dB	120dB	120dB	120dB
Max. IR Distance	30m(98ft)	30m(98ft)	30m(98ft)	30m(98ft)
Video Compression	H.265+/H.265 H.264+/H.264H	H.265+/H.265 H.264+/H.264H	H.265+/H.265 H.264+/H.264H	H.265+/H.265 H.264+/H.264H
Max. Resolution	8M(3840×2160)	5MP(2592×1944)	4MP(2688×1520)	1080P(1920×1080)
Frame Rate	30fps@8MP	15fps@5MP 30fps@3MP	20fps@4MP 30fps@3MP	30fps@1080P
Multi-streaming	2 streams	2 streams	2 streams	2 streams
Pan/Tilt/Rotation	Pan: 0°~360° Tilt: 0°~80° Rotation: 0°~360°	Pan: 0°~360°; Tilt: 0°~80° Rotation: 0°~360°	Pan: 0°~360° Tilt: 0°~80° Rotation: 0°~360°	Pan: 0°~360° Tilt: 0°~80° Rotation: 0°~360°
Intelligent Video	Tripwire, Intrusion	Tripwire, Intrusion	Tripwire, Intrusion	Tripwire, Intrusion
Compatibility	ONVIF profile S&G, API	ONVIF profile S&G, API	ONVIF profile S&G, API	ONVIF profile S&G, API
Audio In/Out	--	--	--	--
Memory Slot	Micro SD, Max. 128GB	Micro SD, Max. 128GB	Micro SD, Max. 128GB	Micro SD, Max. 128GB
Alarm In/Out	--	--	--	--
Ingress Protection	IP67	IP67,IK10	IP67,IK10	IP67,IK10
Working Temperature	-30°C~+60°C(-22°F~+140°F)	-30°C~+60°C(-22°F~+140°F)	-30°C~+60°C(-22°F~+140°F)	-30°C~+60°C(-22°F~+140°F)
Power	DC12V PoE (802.3af)(Class 0) Max. 10.9W	DC12V PoE (802.3af)(Class 0) Max. 9.5W(-ZS), 7.5W(-VFS)	DC12V PoE (802.3af)(Class 0) Max. 9W(-ZS), 7W(-VFS)	DC12V PoE (802.3af)(Class 0) Max. 9W(-ZS), 7W(-VFS)

NETWORK CAMERAS

Lite 2.0 Series

	Vari-Focal Eyeball			Fixed Mini-Bullet		
Model	IPC-HDW2531R-ZS	IPC-HDW2431R-ZS	IPC-HDW2231R-ZS	IPC-HFW1531S	IPC-HFW1431S	IPC-HFW1230S
Appearance	 H.265+	 H.265+	 H.265+	 H.265+	 H.265+	 H.265+
Image Sensor	1/2.7" 5MP CMOS	1/3" 4MP CMOS	1/2.8" 2MP STARVIS™ CMOS	1/2.7" 5MP CMOS	1/3" 4MP CMOS	1/2.7" 2MP CMOS
Lens	2.7~13.5mm/F1.4 Manual(-VFS), Motorized(-ZS)	2.7~13.5mm/F1.4 Motorized	2.7~13.5mm/F1.4 Motorized	2.8mm/F2.0 3.6mm/F2.0	2.8mm/F2.0 3.6mm/F2.0	2.8mm/F2.0 3.6mm/F2.0
FOV-H	95°~27°	104°~28°	106°~29°	96°/78°	104°/87°	104°/92°
Min. Illumination	0.02Lux/F1.4(Color,1/3s,30IRE) 0.2Lux/F1.4(Color,1/30s,30IRE) 0Lux/F1.4(IR on)	0.03Lux/F1.4(Color,1/3s,30IRE) 0.3Lux/F1.4(Color,1/30s,30IRE) 0Lux/F1.4(IR on)	0.006Lux/F1.4(Color,1/3s,30IRE) 0.05Lux/F1.4(Color,1/30s,30IRE) 0Lux/F1.4(IR on)	0.03Lux/F2.0(Color,1/3s,30IRE) 0.3Lux/F2.0(Color,1/30s,30IRE) 0Lux/F2.0(IR on)	0.08Lux/F2.0(Color,1/3s,30IRE) 0.3Lux/F2.0(Color,1/30s,30IRE) 0Lux/F2.0(IR on)	0.08Lux/F2.0(Color,1/3s,30IRE) 0.3Lux/F2.0(Color,1/30s,30IRE) 0Lux/F2.0(IR on)
Day/Night	ICR	ICR	ICR	ICR	ICR	ICR
WDR	120dB	120dB	120dB	120dB	120dB	DWDR
Max. IR Distance	50m(164ft)	50m(164ft)	50m(164ft)	30m(98ft)	30m(98ft)	30m(98ft)
Video Compression	H.265+/H.265 H.264+/H.264H	H.265+/H.265 H.264+/H.264H	H.265+/H.265 H.264+/H.264H	H.265+/H.265 H.264+/H.264H	H.265+/H.265 H.264+/H.264H	H.265+/H.265 H.264+/H.264
Max. Resolution	5MP(2592×1944)	4MP(2688×1520)	1080P(1920×1080)	5MP(2592×1944)	4MP(2688×1520)	1080P(1920×1080)
Frame Rate	15fps@5MP 30fps@3MP	20fps@4MP 30fps@3MP	30fps@1080P	15fps@5MP 30fps@3MP	20fps@4MP 30fps@3MP	30fps@1080P
Multi-streaming	2 streams	2 streams	2 streams	2 streams	2 streams	2 streams
Pan/Tilt/Rotation	Pan: 0°~360° Tilt: 0°~78° Rotation: 0°~360°	Pan: 0°~360° Tilt: 0°~78° Rotation: 0°~360°	Pan: 0°~360° Tilt: 0°~78° Rotation: 0°~360°	Pan: 0°~360° Tilt: 0°~90° Rotation: 0°~360°	Pan: 0°~360° Tilt: 0°~90° Rotation: 0°~360°	Pan: 0°~360° Tilt: 0°~90° Rotation: 0°~360°
Intelligent Video	Tripwire, Intrusion	Tripwire, Intrusion	Tripwire, Intrusion	Tripwire, Intrusion	Tripwire, Intrusion	Tripwire, Intrusion
Compatibility	ONVIF profile S&G, API	ONVIF profile S&G, API	ONVIF profile S&G, API	ONVIF profile S&G, API	ONVIF profile S&G, API	ONVIF profile S&G, API
Audio In/Out	--	--	--	--	--	--
Memory Slot	Micro SD, Max. 128GB	Micro SD, Max. 128GB	Micro SD, Max. 128GB	--	--	--
Alarm In/Out	--	--	--	--	--	--
Ingress Protection	IP67	IP67	IP67	IP67	IP67	IP67
Working Temperature	-30°C~+60°C(-22°F~+140°F)	-30°C~+60°C(-22°F~+140°F)	-30°C~+60°C(-22°F~+140°F)	-30°C~+60°C(-22°F~+140°F)	-30°C~+60°C(-22°F~+140°F)	-30°C~+60°C(-22°F~+140°F)
Power	DC12V PoE (802.3af)(Class 0) Max. 10W	DC12V PoE (802.3af)(Class 0) Max. 9.5W	DC12V PoE (802.3af)(Class 0) Max. 9.5W	DC12V PoE (802.3af)(Class 0) Max. 6W	DC12V PoE (802.3af)(Class 0) Max. 5.5W	DC12V PoE (802.3af)(Class 0) Max. 4.9W

Lite 2.0 Series

	Fixed Mini-Dome			Fixed Eyeball		
Model	IPC-HDBW1531E	IPC-HDBW1431E	IPC-HDBW1230E	IPC-HDW1531S	IPC-HDW1431S	IPC-HDW1230S
Appearance	 H.265+	 H.265+	 H.265+	 H.265+	 H.265+	 H.265+
Image Sensor	1/2.7" 5MP CMOS	1/3" 4MP CMOS	1/2.7" 2MP CMOS	1/2.7" 5MP CMOS	1/3" 4MP CMOS	1/2.7" 2MP CMOS
Lens	2.8mm/F2.0 3.6mm/F2.0	2.8mm/F2.0 3.6mm/F2.0	2.8mm/F2.0 3.6mm/F2.0	2.8mm/F2.0 3.6mm/F2.0	2.8mm/F2.0 3.6mm/F2.0	2.8mm/F2.0 3.6mm/F2.0
FOV-H	96°/78°	104°/87°	104°/92°	96°/78°	104°/87°	104°/92°
Min. Illumination	0.03Lux/F2.0(Color,1/3s,30IRE) 0.3Lux/F2.0(Color,1/30s,30IRE) 0Lux/F2.0(IR on)	0.08Lux/F2.0(Color,1/3s,30IRE) 0.3Lux/F2.0(Color,1/30s,30IRE) 0Lux/F2.0(IR on)	0.08Lux/F2.0(Color,1/3s,30IRE) 0.3Lux/F2.0(Color,1/30s,30IRE) 0Lux/F2.0(IR on)	0.03Lux/F2.0(Color,1/3s,30IRE) 0.3Lux/F2.0(Color,1/30s,30IRE) 0Lux/F2.0(IR on)	0.08Lux/F2.0(Color,1/3s,30IRE) 0.3Lux/F2.0(Color,1/30s,30IRE) 0Lux/F2.0(IR on)	0.08Lux/F2.0(Color,1/3s,30IRE) 0.3Lux/F2.0(Color,1/30s,30IRE) 0Lux/F2.0(IR on)
Day/Night	ICR	ICR	ICR	ICR	ICR	ICR
WDR	120dB	120dB	DWDR	120dB	120dB	DWDR
Max. IR Distance	30m(98ft)	30m(98ft)	30m(98ft)	30m(98ft)	30m(98ft)	30m(98ft)
Video Compression	H.265+/H.265 H.264+/H.264H	H.265+/H.265 H.264+/H.264H	H.265+/H.265 H.264+/H.264	H.265+/H.265 H.264+/H.264H	H.265+/H.265 H.264+/H.264H	H.265+/H.265 H.264+/H.264
Max. Resolution	5MP(2592×1944)	4MP(2688×1520)	1080P(1920×1080)	5MP(2592×1944)	4MP(2688×1520)	1080P(1920×1080)
Frame Rate	15fps@5MP 30fps@3MP	20fps@4MP 30fps@3MP	30fps@1080P	15fps@5MP 30fps@3MP	20fps@4MP 30fps@3MP	30fps@1080P
Multi-streaming	2 streams	2 streams	2 streams	2 streams	2 streams	2 streams
Pan/Tilt/Rotation	Pan: 0°~355° Tilt: 0°~65° Rotation: 0°~355°	Pan: 0°~355° Tilt: 0°~65° Rotation: 0°~355°	Pan: 0°~355° Tilt: 0°~65° Rotation: 0°~355°	Pan: 0°~360° Tilt: 0°~90° Rotation: 0°~360°	Pan: 0°~360° Tilt: 0°~90° Rotation: 0°~360°	Pan: 0°~360° Tilt: 0°~90° Rotation: 0°~360°
Intelligent Video	Tripwire, Intrusion	Tripwire, Intrusion	Tripwire, Intrusion	Tripwire, Intrusion	Tripwire, Intrusion	Tripwire, Intrusion
Compatibility	ONVIF profile S&G, API	ONVIF profile S&G, API	ONVIF profile S&G, API	ONVIF profile S&G, API	ONVIF profile S&G, API	ONVIF profile S&G, API
Audio In/Out	--	--	--	--	--	--
Memory Slot	--	--	--	--	--	--
Alarm In/Out	--	--	--	--	--	--
Ingress Protection	IP67,IK10	IP67,IK10	IP67,IK10	IP67	IP67	IP67
Working Temperature	-30°C~-60°C(-22°F~+140°F)	-30°C~-60°C(-22°F~+140°F)	-30°C~-60°C(-22°F~+140°F)	-30°C~-60°C(-22°F~+140°F)	-30°C~-60°C(-22°F~+140°F)	-30°C~-60°C(-22°F~+140°F)
Power	DC12V PoE (802.3af)(Class 0) Max. 6W	DC12V PoE (802.3af)(Class 0) Max. 5.5W	DC12V PoE (802.3af)(Class 0) Max. 4.6W	DC12V PoE (802.3af)(Class 0) Max. 6W	DC12V PoE (802.3af)(Class 0) Max. 5.5W	DC12V PoE (802.3af)(Class 0) Max. 4.3W

NETWORK CAMERAS

Access ANPR Cameras

Access ANPR Cameras

Access ANPR cameras are designed for license plate monitoring in low speed scenarios, such as parking lots, gas stations, campus streets, etc. It is suitable for vehicle entrance & exit management as it has a whitelist function and the ability to control barrier gates. With embedded ANPR algorithms and true WDR, the Access ANPR camera can accurately detect and recognize vehicle license plates in all environments.

⊕ KEY FEATURES

Easy & Stable

Simple wizard-guided setup. True WDR and auto ICR suits all environments

Advanced Management

Embedded white/black list; Relay out port to control barriers

Cost-Effective

Embedded ANPR algorithm saves on cost of maintaining smart servers

Well-Designed Solutions

Work with NVR Pro series for lite solution; EMS/PMS/DSS platforms for professional solutions

* Compatible with NVR Pro series (NVR5X)

Access ANPR			
Model	ITC237-PW1B-IRZ	ITC237-PU1B-IR	ITC237-PU1B-L
Appearance			
WDR	140dB	140dB	140dB
Max. Lighting Distance	IR: 8m(26ft)	IR: 40m(131ft)	White Light: 40m(131ft)
Video Compression	H.265/H.264M/H.264H/H.264B	H.265/H.264M/H.264H/H.264B	H.265/H.264M/H.264H/H.264B
Max. Resolution	2M (1920×1080)	2M (1920×1080)	2M (1920×1080)
Frame Rate	25fps@1080P	25fps@1080P	25fps@1080P
Multi-streaming	2 streams	2 streams	2 streams
Pan/Tilt/Rotation	Pan: 0°~360°; Tilt: 0°~90° Rotation: 0°~360°	--	--
Intelligent Video	Embedded ANPR, 3~8m 1 lane width max 40Kmh 10000 whitelist & black list Relay out to control barrier	Embedded ANPR, 4~40m 2 lanes width max 70Kmh 10000 whitelist & black list Relay out to control barrier	Embedded ANPR, 4~40m 2 lanes width max 70Kmh 10000 whitelist & black list Relay out to control barrier
CoMPatibility	ONVIF, API	ONVIF, API	ONVIF, API
Audio In/Out	1/1	2/1	2/1
Memory Slot	Micro SD, Max. 64GB	Micro SD, Max. 64GB	Micro SD, Max. 64GB
Alarm In/Out	1/1	2/2	2/2
Ingress Protection	IP67, IK10	IP66	IP66
Working TeMPurature	-40°C~+60°C (-40°F ~ +140°F)	-30°C~+60°C (-22°F ~ +140°F)	-30°C~+60°C (-22°F ~ +140°F)
Power	DC12V,PoE (802.3af) Max. 12W	PoE+ (802.3at) Max. 17W	PoE+ (802.3at) Max. 17W

NETWORK PTZ CAMERAS



NETWORK PTZ CAMERAS

Ultra Series

Ultra Series

The Ultra Series PTZ is designed for projects with the highest quality and performance requirements. With high performance Sony camera sensors, IP67 & IK10, and extra-long distance IR, this range is capable of handling any type of scenario.

⊕ KEY FEATURES

Advanced Sensors

High sensitivity & low noise with back-illuminated pixel technology

Superior Image

Starlight / Ultra 140dB WDR provides clear image under any light conditions

Automated Surveillance

Intelligent auto-tracking PTZ tracks suspicious objects

Powerful Protection

IP67 / IK10 ratings ensures cameras can withstand tough conditions

Super IR Range

Cameras provide up to 550m IR range for performance in dark environments





Powerful Zoom

30x/40x/45x/48x optical zoom easily covers large areas

PFA

Improve focusing performance to a new level

Outdoor IR PTZ Camera

Model	SD10A248V-HNI	SD8A840VI-HNI	SD8A240VI-HNI	SD6AE830V-HNI	SD6AE240V-HNI
Appearance	 H.265+ Starlight	 4K H.265+ Starlight	 H.265+ Starlight	 4K H.265+	 Ultra WDR H.265+ Starlight
Image Sensor	1/1.9" 2MP CMOS	1/1.8" 8MP STARVIS™ CMOS	1/1.9" 2MP CMOS	1/1.7" 12MP STARVIS™ CMOS	1/2.8" 2MP STARVIS™ CMOS
Lens	5.7~275mm (48x Optical zoom)	5.6~223mm (40x Optical zoom)	5.6~223mm (40x Optical zoom)	6~180mm (30x Optical zoom)	4.5~180mm (40x Optical zoom)
FOV-H	64.6°~1.5°	69.8° ~ 1.9°	69.8° ~ 1.9°	61.2°~2.1°	67.5° ~ 1.7°
Min. Illumination	0.001Lux/F1.4(Color) 0Lux/F1.4(IR on)	0.002Lux/F1.35(Color) 0Lux/F1.35(IR on)	0.001Lux/F1.35(Color) 0Lux/F1.35(IR on)	0.05Lux/F1.6(Color) 0Lux/F1.6(IR on)	0.005Lux/F1.6(Color) 0Lux/F1.6(IR on)
WDR	120dB	120dB	120dB	DWDR	140dB
Max. IR Distance	450m(1476ft)	450m(1476ft)	450m(1476ft)	200m(656ft)	200m(656ft)
Video Compression	H.265+/H.265 H.264+/H.264	H.265+/H.265 H.264+/H.264	H.265+/H.265 H.264+/H.264	H.265+/H.265 H.264+/H.264	H.265+/H.265 H.264+/H.264
Max. Resolution	1080P(1920×1080)	4K(3840×2160)	1080P(1920×1080)	4K(3840×2160)	1080P(1920×1080)
Frame Rate	60fps@1080P	30fp@4K	60fp@1080P	30fps@4K	60fp@1080P
Multi-streaming	3 streams	3 streams	3 streams	3 streams	3 streams
Pan/Tilt	Pan: 0°~360° endless Tilt: -30°~90°	Pan: 0° ~ 360° endless Tilt: -30° ~ 90°	Pan: 0° ~ 360° endless Tilt: -30° ~ 90°	Pan: 0°~360° endless Tilt: -20°~90°	Pan: 0°~360° endless Tilt: -20°~90°
Preset Speed	Pan: 240°/s; Tilt: 200°/s	Pan: 240° /s; Tilt: 120° /s	Pan: 240° /s; Tilt: 120° /s	Pan: 240°/s; Tilt: 200°/s	Pan: 240°/s; Tilt: 200°/s
Auto Tracking	Supported	Supported	Supported	Supported	Supported
Intelligent Video	Tripwire, Intrusion Abandoned/Missing Face Detection	Tripwire, Intrusion Abandoned/Missing Face detection	Tripwire, Intrusion Abandoned/Missing Face detection	Tripwire, Intrusion Abandoned/Missing Face Detection	Tripwire, Intrusion Abandoned/Missing Face Detection
Compatibility	ONVIF profile S&G, API	ONVIF profileS&G, API	ONVIF profileS&G, API	ONVIF profile S&G, API	ONVIF profile S&G, API
Audio In/Out	1/1	1/1	1/1	1/1	1/1
Memory Slot	Micro SD, Max. 256GB	Micro SD, Max 256GB	Micro SD, Max 256GB	Micro SD, Max. 256GB	Micro SD, Max. 256GB
Alarm In/Out	7/2	7/2	7/2	7/2	7/2
Ingress Protection	IP67	IP67	IP67	IP67, IK10	IP67, IK10
Working Temperature	-40°C~+70°C(-40°F~+158°F)	-40°C~+70°C(-40°F~+158°F)	-40°C~+70°C(-40°F~+158°F)	-40°C~+70°C(-40°F~+158°F)	-40°C~+70°C(-40°F~+158°F)
Power	AC24V, Hi-PoE Max. 38W	AC24V, Hi-PoE Max. 38W	AC24V, Hi-PoE Max. 38W	AC24V, Hi-PoE Max. 38W	AC24V, Hi-PoE Max. 38W

NETWORK PTZ CAMERAS

NETWORK PTZ CAMERAS

Ultra Series

NETWORK PTZ CAMERAS

	Outdoor IR PTZ Camera	Outdoor Laser PTZ Camera			Outdoor IR PTZ Camera	Outdoor PTZ Camera
Model	SD6AE230F-HNI	SD6AL830V-HNI	SD6AL245U-HNI	SD6AL230F-HNI	SD6AL245U-HNI-IR	SD65F230F-HNI
Appearance	 Starlight	 4K H.265+	 H.265+ Starlight	 Starlight	 H.265+ Starlight	 Starlight
Image Sensor	1/1.9" 2MP CMOS	1/1.7" 12MP STARVIS™ CMOS	1/2.8" 2MP STARVIS™ CMOS	1/1.9" 2MP CMOS	1/2.8" 2MP STARVIS™ CMOS	1/1.9" 2MP CMOS
Lens	6~180mm(30x Optical zoom)	6~180mm(30x Optical zoom)	3.95~177.7mm(45x Optical zoom)	6~180mm(30x Optical zoom)	3.95~177.7mm(45x Optical zoom)	6~180mm(30x Optical zoom)
FOV-H	61.2°~2.1°	61.2°~2.1°	70.3°~1.8°	61.2°~2.1°	70.3°~1.8°	61.2°~2.1°
Min. Illumination	0.002Lux/F1.5(Color) 0Lux/F1.5(IR on)	0.05Lux/F1.6(Color) 0Lux/F1.6(IR on)	0.005Lux/F1.6(Color) 0Lux/1.6(IR on)	0.002Lux/F1.5(Color) 0Lux/F1.5(IR on)	0.005Lux/F1.6(Color) 0Lux/1.6(IR on)	0.002Lux/F1.5(Color) 0.0002Lux/F1.5(B/W)
WDR	120dB	DWDR	120dB	120dB	120dB	120dB
Max. IR Distance	200m(656ft)	500m(1640ft)	550m(1804ft)	500m(1640ft)	300m(984ft)	--
Video Compression	H.264	H.265+/H.265/H.264+/H.264	H.265+/H.265/H.264+/H.264	H.264	H.265+/H.265/H.264+/H.264	H.264
Max. Resolution	1080P(1920×1080)	4K(3840×2160)	1080P(1920×1080)	1080P(1920×1080)	1080P(1920×1080)	1080P(1920×1080)
Frame Rate	30fps@1080P, 60fps@720P	30fps@4K	60fp@1080P	30fps@1080P, 60fps@720P	60fp@1080P	30fps@1080P, 60fps@720P
Multi-streaming	3 streams	3 streams	3 streams	3 streams	3 streams	3 streams
Pan/Tilt	Pan: 0°~360° endless Tilt: -20°~90°	Pan: 0°~360° endless Tilt: -20°~90°	Pan: 0°~360° endless Tilt: -20°~90°	Pan: 0°~360° endless Tilt: -20°~90°	Pan: 0°~360° endless Tilt: -20°~90°	Pan: 0°~360° endless Tilt: -20°~90°
Preset Speed	Pan: 240°/s; Tilt: 200°/s	Pan: 240°/s; Tilt: 200°/s	Pan: 240°/s; Tilt: 200°/s	Pan: 240°/s; Tilt: 200°/s	Pan: 240°/s; Tilt: 200°/s	Pan: 600°/s; Tilt: 500°/s
Auto Tracking	Supported	Supported	Supported	Supported	Supported	Supported
Intelligent Video	Tripwire, Intrusion Abandoned/Missing Face Detection	Tripwire, Intrusion Abandoned/Missing Face Detection	Tripwire, Intrusion Abandoned/Missing Face Detection	Tripwire, Intrusion Abandoned/Missing Face Detection	Tripwire, Intrusion Abandoned/Missing Face Detection	Tripwire, Intrusion Abandoned/Missing Face Detection
Compatibility	ONVIF profile S&G, API	ONVIF profile S&G, API	ONVIF profile S&G, API	ONVIF profile S&G, API	ONVIF profile S&G, API	ONVIF profile S&G, API
Audio In/Out	1/1	1/1	1/1	1/1	1/1	1/1
Memory Slot	Micro SD, Max. 128GB	Micro SD, Max. 256GB	Micro SD, Max. 256GB	Micro SD, Max. 128GB	Micro SD, Max. 256GB	Micro SD, Max. 128GB
Alarm In/Out	7/2	7/2	7/2	7/2	7/2	7/2
Ingress Protection	IP67, IK10	IP67	IP67	IP67	IP67	IP67, IK10
Working Temperature	-40°C~+70°C(-40°F~+158°F)	-40°C~+70°C(-40°F~+158°F)	-40°C~+60°C(-40°F~+140°F)	-40°C~+70°C(-40°F~+158°F)	-40°C~+60°C(-40°F~+140°F)	-40°C~+70°C(-40°F~+158°F)
Power	AC24V, Hi-PoE Max. 38W	AC24V, Hi-PoE Max. 38W	AC24V, Hi-PoE Max. 38W	AC24V, Hi-PoE Max. 38W	AC24V, Hi-PoE Max. 38W	AC24V, PoE+(802.3at) Max. 20W

NETWORK PTZ CAMERAS

Pro Series

The Pro Series PTZ is designed to meet high image quality and low-light surveillance requirements with the help of Starlight technology. Rich housing and model selections are available to meet diverse application needs.

⊕ KEY FEATURES

Great Selection

Wide range of housings and models to suit all requirements

Advanced Intelligence

IVS, auto-tracking, and face detection ensure efficient surveillance

H.265

Advanced encoding saves up to 50% bandwidth and storage

Powerful Protection

IP67 / IK10 ratings ensures cameras can withstand tough conditions

Optimized Image





High quality image with Starlight technology

PFA

Improve focusing performance to a new level

Pro Series







Outdoor IR PTZ Camera

Model	SD6CE245U-HNI	SD6CE230U-HNI	SD6CE225U-HNI	SD6C430U-HNI
Appearance	 H.265+ Starlight	 H.265+ Starlight	 H.265+ Starlight	 H.265+
Image Sensor	1/2.8" 2MP STARVIS™ CMOS	1/2.8" 2MP STARVIS™ CMOS	1/2.8" 2MP STARVIS™ CMOS	1/3" 4MP CMOS
Lens	3.95~177.7mm (45x Optical zoom)	4.5~135mm (30x Optical zoom)	4.8~120mm (25x Optical zoom)	4.5~135mm (30x Optical zoom)
FOV-H	70.3°~1.8°	67.8°~2.4°	62.8°~2.6°	60°~2.2°
Min. Illumination	0.005Lux/F1.6(Color) 0Lux/F1.6(IR on)	0.005Lux/F1.6(Color) 0Lux/F1.6(IR on)	0.005Lux/F1.6(Color) 0Lux/F1.6(IR on)	0.05Lux/F1.6(Color) 0Lux/F1.6(IR on)
WDR	120dB	120dB	120dB	120dB
Max. IR Distance	250m(820ft)	200m(656ft)	200m(656ft)	100m(328ft)
Video Compression	H.265+/H.265 H.264+/H.264	H.265+/H.265 H.264+/H.264	H.265+/H.265 H.264+/H.264	H.265+/H.265 H.264+/H.264
Max. Resolution	1080P(1920×1080)	1080P(1920×1080)	1080P(1920×1080)	4MP(2592×1520)
Frame Rate	60fp@1080P	60fp@1080P	60fp@1080P	30fps@4MP/3MP 60fps@1080P
Multi-streaming	3 streams	3 streams	3 streams	3 streams
Pan/Tilt	Pan: 0°~360° endless Tilt: -20°~90°	Pan: 0°~360° endless Tilt: -20°~90°	Pan: 0°~360° endless Tilt: -20°~90°	Pan: 0°~360° endless Tilt: -15°~90°
Preset Speed	Pan: 300°/s; Tilt: 200°/s	Pan: 300°/s; Tilt: 200°/s	Pan: 300°/s; Tilt: 200°/s	Pan: 240°/s; Tilt: 200°/s
Auto Tracking	Supported	Supported	Supported	Supported
Intelligent Video	Tripwire, Intrusion Abandoned/Missing Face Detection	Tripwire, Intrusion Abandoned/Missing Face Detection	Tripwire, Intrusion Abandoned/Missing Face Detection	Tripwire, Intrusion Abandoned/Missing Face Detection
Compatibility	ONVIF profile S&G, API	ONVIF profile S&G, API	ONVIF profile S&G, API	ONVIF profile S&G, API
Audio In/Out	1/1	1/1	1/1	1/1
Memory Slot	Micro SD, Max. 256GB	Micro SD, Max. 256GB	Micro SD, Max. 256GB	Micro SD, Max. 256GB
Alarm In/Out	7/2	7/2	7/2	2/1
Ingress Protection	IP67, IK10	IP67, IK10	IP67, IK10	IP66
Working Temperature	-40°C~+70°C(-40°F~+158°F)	-40°C~+70°C(-40°F~+158°F)	-40°C~+70°C(-40°F~+158°F)	-40°C~+60°C(-40°F~+140°F)
Power	AC24V, PoE+(802.3at) Max. 25W	AC24V, PoE+(802.3at) Max. 25W	AC24V, PoE+(802.3at) Max. 25W	AC24V Max. 26W

NETWORK PTZ CAMERAS





Pro Series

NETWORK PTZ CAMERAS

	Outdoor PTZ Camera			Outdoor IR PTZ Camera		
Model	SD60430U-HNI	SD60230U-HNI	SD60225U-HNI	SD59430U-HNI	SD59230U-HNI	SD59225U-HNI
Appearance	 H.265+	 H.265+ Starlight	 H.265+ Starlight	 H.265+	 H.265+ Starlight	 H.265+ Starlight
Image Sensor	1/3" 4MP CMOS	1/2.8" 2MP STARVIS™ CMOS	1/2.8" 2MP STARVIS™ CMOS	1/3" 4MP CMOS	1/2.8" 2MP STARVIS™ CMOS	1/2.8" 2MP STARVIS™ CMOS
Lens	4.5~135mm (30x Optical zoom)	4.5~135mm (30x Optical zoom)	4.8~120mm (25x Optical zoom)	4.5~135mm (30x Optical zoom)	4.5~135mm (30x Optical zoom)	4.8~120mm (25x Optical zoom)
FOV-H	60°~2.2°	67.8°~2.4°	62.8°~2.6°	60°~2.2°	67.8°~2.4°	62.8°~2.6°
Min. Illumination	0.05Lux/F1.6(Color) 0.005Lux/F1.6(B/W)	0.005Lux/F1.6(Color) 0.0005Lux/F1.6(B/W)	0.005Lux/F1.6(Color) 0.0005Lux/F1.6(B/W)	0.05Lux/F1.6(Color) 0Lux/F1.6(IR on)	0.005Lux/F1.6(Color) 0Lux/F1.6(IR on)	0.005Lux/F1.6(Color) 0Lux/F1.6(IR on)
WDR	120dB	120dB	120dB	120dB	120dB	120dB
Max. IR Distance	--	--	--	100m(328ft)	150m(492ft)	150m(492ft)
Video Compression	H.265+/H.265 H.264+/H.264	H.265+/H.265 H.264+/H.264	H.265+/H.265 H.264+/H.264	H.265+/H.265 H.264+/H.264	H.265+/H.265 H.264+/H.264	H.265+/H.265 H.264+/H.264
Max. Resolution	4MP(2592×1520)	1080P(1920×1080)	1080P(1920×1080)	4MP(2592×1520)	1080P(1920×1080)	1080P(1920×1080)
Frame Rate	30fps@4MP/3MP 60fps@1080P	60fps@1080P	60fps@1080P	30fps@4MP/3MP 60fps@1080P	60fps@1080P	60fps@1080P
Multi-streaming	3 streams	3 streams	3 streams	3 streams	3 streams	3 streams
Pan/Tilt	Pan: 0°~360° endless Tilt: -20°~90°	Pan: 0°~360° endless Tilt: -20°~90°	Pan: 0°~360° endless Tilt: -20°~90°	Pan: 0°~360° endless Tilt: -15°~90°	Pan: 0°~360° endless Tilt: -15°~90°	Pan: 0°~360° endless Tilt: -15°~90°
Preset Speed	Pan: 600°/s; Tilt: 500°/s	Pan: 600°/s; Tilt: 500°/s	Pan: 600°/s; Tilt: 500°/s	Pan: 400°/s; Tilt: 300°/s	Pan: 400°/s; Tilt: 300°/s	Pan: 400°/s; Tilt: 300°/s
Auto Tracking	Supported	Supported	Supported	Supported	Supported	Supported
Intelligent Video	Tripwire, Intrusion Abandoned/Missing Face Detection	Tripwire, Intrusion Abandoned/Missing Face Detection	Tripwire, Intrusion Abandoned/Missing Face Detection	Tripwire, Intrusion Abandoned/Missing Face Detection	Tripwire, Intrusion Abandoned/Missing Face Detection	Tripwire, Intrusion Abandoned/Missing Face Detection
Compatibility	ONVIF profile S&G, API	ONVIF profile S&G, API	ONVIF profile S&G, API	ONVIF profile S&G, API	ONVIF profile S&G, API	ONVIF profile S&G, API
Audio In/Out	1/1	1/1	1/1	1/1	1/1	1/1
Memory Slot	Micro SD, Max. 256GB	Micro SD, Max. 256GB	Micro SD, Max. 256GB	Micro SD, Max. 256GB	Micro SD, Max. 256GB	Micro SD, Max. 256GB
Alarm In/Out	7/2	7/2	7/2	2/1	2/1	2/1
Ingress Protection	IP67, IK10	IP67, IK10	IP67, IK10	IP66	IP66	IP66
Working Temperature	-40°C~+70°C(-40°F~+158°F)	-40°C~+70°C(-40°F~+158°F)	-40°C~+70°C(-40°F~+158°F)	-40°C~+70°C(-40°F~+158°F)	-40°C~+70°C(-40°F~+158°F)	-40°C~+70°C(-40°F~+158°F)
Power	AC24V, PoE+(802.3at) Max. 20W	AC24V, PoE+(802.3at) Max. 20W	AC24V, PoE+(802.3at) Max. 20W	AC24V, PoE+(802.3at) Max. 23W	AC24V, PoE+(802.3at) Max. 23W	AC24V, PoE+(802.3at) Max. 23W

NETWORK PTZ CAMERAS

Pro Series

	Outdoor PTZ Camera			In-ceiling PTZ Camera			IR Housing Zoom Camera	Zoom Camera
Model	SD50430U-HNI	SD50230U-HNI	SD50225U-HNI	SD52C430U-HNI	SD52C230U-HNI	SD52C225U-HNI	SDZW2030S-N	SDZ2030S-N
Appearance								
Image Sensor	1/3" 4MP CMOS	1/2.8" 2MP STARVIS™ CMOS	1/2.8" 2MP STARVIS™ CMOS	1/3" 4MP CMOS	1/2.8" 2MP STARVIS™ CMOS	1/2.8" 2MP STARVIS™ CMOS	1/2.8" 2MP STARVIS™ CMOS	1/2.8" 2MP STARVIS™ CMOS
Lens	4.5~135mm (30x Optical zoom)	4.5~135mm (30x Optical zoom)	4.8~120mm (25x Optical zoom)	4.5~135mm (30x Optical zoom)	4.5~135mm (30x Optical zoom)	4.8~120mm (25x Optical zoom)	4.5~135mm (30x Optical zoom)	4.5~135mm (30x Optical zoom)
FOV-H	60°~2.2°	67.8°~2.4°	62.8°~2.6°	60°~2.2°	67.8°~2.4°	62.8°~2.6°	67.8°~2.4°	67.8°~2.4°
Min. Illumination	0.05Lux/F1.6(Color) 0.005Lux/F1.6(B/W)	0.005Lux/F1.6(Color) 0.0005Lux/F1.6(B/W)	0.005Lux/F1.6(Color) 0.0005Lux/F1.6(B/W)	0.05Lux/F1.6(Color) 0.005Lux/F1.6(B/W)	0.005Lux/F1.6(Color) 0.0005Lux/F1.6(B/W)	0.005Lux/F1.6(Color) 0.0005Lux/F1.6(B/W)	0.005Lux/F1.6(Color) 0Lux/F1.6(IR on)	0.005Lux/F1.6(Color) 0.0005Lux/F1.6(B/W)
WDR	120dB	120dB	120dB	120dB	120dB	120dB	120dB	120dB
Max. IR Distance	--	--	--	--	--	--	150m(492ft)	--
Video Compression	H.265+/H.265 H.264+/H.264	H.265+/H.265 H.264+/H.264	H.265+/H.265 H.264+/H.264	H.265+/H.265 H.264+/H.264	H.265+/H.265 H.264+/H.264	H.265+/H.265 H.264+/H.264	H.265+/H.265 H.264+/H.264	H.265+/H.265 H.264+/H.264
Max. Resolution	4MP(2592×1520)	1080P(1920×1080)	1080P(1920×1080)	4MP(2592×1520)	1080P(1920×1080)	1080P(1920×1080)	1080P(1920×1080)	1080P(1920×1080)
Frame Rate	30fps@4MP/3MP 60fps@1080P	60fps@1080P	60fps@1080P	30fps@4MP/3MP 60fps@1080P	60fps@1080P	60fps@1080P	60fps@1080P	60fps@1080P
Multi-streaming	3 streams	3 streams	3 streams	3 streams	3 streams	3 streams	3 streams	3 streams
Pan/Tilt	Pan: 0°~360° endless Tilt: 0°~90°	Pan: 0°~360° endless Tilt: 0°~90°	Pan: 0°~360° endless Tilt: 0°~90°	Pan: 0°~360° endless Tilt: 0°~90°	Pan: 0°~360° endless Tilt: 0°~90°	Pan: 0°~360° endless Tilt: 0°~90°	--	--
Presets Speed	Pan: 500°/s; Tilt: 500°/s	Pan: 500°/s; Tilt: 500°/s	Pan: 500°/s; Tilt: 500°/s	Pan: 500°/s; Tilt: 500°/s	Pan: 500°/s; Tilt: 500°/s	Pan: 500°/s; Tilt: 500°/s	--	--
Auto Tracking	Supported	Supported	Supported	Supported	Supported	Supported	--	--
Intelligent Video	Tripwire, Intrusion Abandoned/Missing Face Detection	Tripwire, Intrusion Abandoned/Missing Face Detection	Tripwire, Intrusion Abandoned/Missing Face Detection	Tripwire, Intrusion Abandoned/Missing Face Detection	Tripwire, Intrusion Abandoned/Missing Face Detection	Tripwire, Intrusion Abandoned/Missing Face Detection	Tripwire, Intrusion Abandoned/Missing Face Detection	Tripwire, Intrusion Abandoned/Missing Face Detection
Compatibility	ONVIF profile S&G, API	ONVIF profile S&G, API	ONVIF profile S&G, API	ONVIF profile S&G, API	ONVIF profile S&G, API	ONVIF profile S&G, API	ONVIF profile S&G, API	ONVIF profile S&G, API
Audio In/Out	1/1	1/1	1/1	1/1	1/1	1/1	1/1	1/1
Memory Slot	Micro SD, Max. 256GB	Micro SD, Max. 256GB	Micro SD, Max. 256GB	Micro SD, Max. 256GB	Micro SD, Max. 256GB	Micro SD, Max. 256GB	Micro SD, Max. 256GB	Micro SD, Max. 256GB
Alarm In/Out	2/1	2/1	2/1	2/1	2/1	2/1	2/1	2/1
Ingress Protection	IP67, IK10	IP67, IK10	IP67, IK10	IK10	IK10	IK10	IP66	--
Working Temperature	-40°C~-60°C(-40°F~-140°F)	-40°C~-60°C(-40°F~-140°F)	-40°C~-60°C(-40°F~-140°F)	-30°C~-60°C(-22°F~-140°F)	-30°C~-60°C(-22°F~-140°F)	-30°C~-60°C(-22°F~-140°F)	-40°C~-70°C(-40°F~-158°F)	-40°C~-70°C(-40°F~-158°F)
Power	AC24V, PoE+(802.3at) Max. 23W	AC24V, PoE+(802.3at) Max. 23W	AC24V, PoE+(802.3at) Max. 23W	AC24V, PoE+(802.3at) Max. 13W	AC24V, PoE+(802.3at) Max. 13W	AC24V, PoE+(802.3at) Max. 13W	DC12V Max. 50W	DC12V, PoE(802.3af) Max. 10W

NETWORK PTZ CAMERAS

Lite Series

The Lite Series PTZ offers a cost/performance solution suitable for a range of applications. Its compact design built with Dahua quality standards and assurance enables the entire range to meet your requirements.

⊕ KEY FEATURES

Compact Design

Small PTZ cameras; Can fit in a number of places

Mini IR PTZ

Pan / tilt / zoom and IR functionality in compact housing

Advanced Intelligence

IVS and Face Detection ensure efficient surveillance

Powerful Zoom

Up to 25x optical zoom easily covers large areas





Cost-Effective

Performance and quality are combined at an affordable price

PFA









Improve focusing performance to a new level

Lite Series

	Outdoor IR PTZ Camera			Outdoor PTZ Camera	Indoor PTZ Camera
Model	SD49412T-HN	SD49225T-HN	SD49212T-HN	SD40212T-HN (-S2)	SD42212T-HN (-S2)
Appearance	 H.265	 H.265+ Starlight	 H.265+ Starlight	 H.265+ Starlight	 H.265+ Starlight
Image Sensor	1/3" 4MP CMOS	1/2.8" 2MP STARVIS™ CMOS	1/2.8" 2MP STARVIS™ CMOS	1/2.8" 2MP STARVIS™ CMOS	1/2.8" 2MP STARVIS™ CMOS
Lens	5.3~64mm (12x Optical zoom)	4.8~120mm (25x Optical zoom)	5.3~64mm (12x Optical zoom)	5.3~64mm (12x Optical zoom)	5.3~64mm (12x Optical zoom)
FOV-H	58.2°~4.8°	62.8°~2.6°	58.2°~4.8°	58.2°~4.8°	58.2°~4.8°
Min. Illumination	0.05Lux/F1.6(Color) 0Lux/F1.6(IR on)	0.005Lux/F1.6(Color) 0Lux/F1.6(IR on)	0.005Lux/F1.6(Color) 0Lux/F1.6(IR on)	0.005Lux/F1.6(Color) 0.0005Lux/F1.6 (B/W)	0.005Lux/F1.6(Color) 0.0005Lux/F1.6 (B/W)
WDR	120dB	120dB	120dB	120dB	120dB
Max. IR Distance	100m(328ft)	100m(328ft)	100m(328ft)	--	--
Video Compression	H.265/H.264	H.265+/H.265 H.264+/H.264	H.265+/H.265 H.264+/H.264	H.265+/H.265 H.264+/H.264	H.265+/H.265 H.264+/H.264
Max. Resolution	4MP(2592×1520)	1080P(1920×1080)	1080P(1920×1080)	1080P(1920×1080)	1080P(1920×1080)
Frame Rate	30fps@4MP/3MP	30fps@1080P	30fps@1080P	30fp@1080P	30fp@1080P
Multi-streaming	3 streams	3 streams	3 streams	3 streams	3 streams
Pan/Tilt	Pan: 0°~360° endless Tilt: -15°~90°	Pan: 0°~360° endless Tilt: -15°~90°	Pan: 0°~360° endless Tilt: -15°~90°	Pan: 0°~360° endless Tilt: -2°~90°	Pan: 0°~360° endless Tilt: -2°~90°
Preset Speed	Pan: 240°/s, Tilt: 200°/s	Pan: 240°/s, Tilt: 200°/s	Pan: 240°/s, Tilt: 200°/s	Pan: 300°/s, Tilt: 200°/s	Pan: 300°/s; Tilt: 200°/s
Intelligent Video	Tripwire, Intrusion Abandoned/Missing Face Detection	Tripwire, Intrusion Abandoned/Missing Face Detection	Tripwire, Intrusion Abandoned/Missing Face Detection	Tripwire, Intrusion Abandoned/Missing Face Detection	Tripwire, Intrusion Abandoned/Missing Face Detection
Compatibility	ONVIF profile S&G, API	ONVIF profile S&G, API	ONVIF profile S&G, API	ONVIF profile S&G, API	ONVIF profile S&G, API
Audio In/Out	1/1	1/1	1/1	1/1	1/1
Memory Slot	Micro SD, Max. 256GB	Micro SD, Max. 256GB	Micro SD, Max. 256GB	Micro SD, Max. 256GB	Micro SD, Max. 256GB
Alarm In/Out	2/1	2/1	2/1	2/1	2/1
Ingress Protection	IP66	IP66	IP66	IP66, IK10	IP66, IK10
Working Temperature	-40°C~+70°C(-40°F~+158°F)	-40°C~+70°C(-40°F~+158°F)	-40°C~+70°C(-40°F~+158°F)	-40°C~+60°C(-40°F~+140°F)	-30°C~+60°C(-22°F~+140°F)
Power	DC12V, PoE+(802.3at) Max. 20W	DC12V, PoE+(802.3at) Max. 20W	DC12V, PoE+(802.3at) Max. 20W	AC24V, PoE+(802.3at) Max. 22W	AC24V, PoE+(802.3at) Max. 12W

NETWORK PTZ CAMERAS

Lite Series

	In-ceiling PTZ Camera	Mini IR PTZ Camera	Mini PTZ Camera		Mini IR PTZ Camera	Mini IR PT Camera	Mini PTZ Camera	Mini PT Camera
Model	SD42C212T-HN (-S2)	SD29204T-GN	SD22404T-GN	SD22204T-GN	SD1A203T-GN	SD1A200T-GN	SD12203T-GN	SD12200T-GN
Appearance	 H.265+ Starlight	 reddot award 2015 winner	 H.265		 H.265+ Starlight	 H.265+ Starlight	 H.265+ Starlight	 H.265+ Starlight
Image Sensor	1/2.8" 2MP STARVIS™ CMOS	1/2.7" 2MP CMOS	1/3" 4MP CMOS	1/2.7" 2MP CMOS	1/2.8" 2MP STARVIS™ CMOS	1/2.8" 2MP STARVIS™ CMOS	1/2.8" 2MP STARVIS™ CMOS	1/2.8" 2MP STARVIS™ CMOS
Lens	5.3~64mm (12x Optical zoom)	2.7~11mm (4x Optical zoom)	2.7~11mm (4x Optical zoom)	2.7~11mm (4x Optical zoom)	2.7~8.1mm (3x optical zoom)	2.8mm/F1.6 3.6mm/F1.6	2.7~8.1mm (3x optical zoom)	2.8mm/F1.6 3.6mm/F1.6
FOV-H	58.2°~4.8°	112.5°~30°	112.5°~30°	112.5°~30°	105.6° ~ 35.2°	102.9°/80.9°	105.6° ~ 35.2°	102.9°/80.9°
Min. Illumination	0.005Lux/F1.6(Color) 0.0005Lux/F1.6 (B/W)	0.05Lux/F1.6(Color) 0Lux/F1.6(IR on)	0.05Lux/F1.6(Color) 0.005Lux/F1.6(B/W)	0.05Lux/F1.6(Color) 0.005Lux/F1.6(B/W)	0.005Lux/F1.8(Color) 0Lux/F1.8 (IR on)	0.005Lux/F1.6(Color) 0Lux/F1.6 (IR on)	0.005Lux/F1.8(Color) 0.0005Lux/F1.8 (B/W)	0.005Lux/F1.6(Color) 0.0005Lux/F1.6 (B/W)
WDR	120dB	120dB	120dB	120dB	120dB	120dB	120dB	120dB
Max. IR Distance	--	30m(98ft)	--	--	15m(49ft)	15m(49ft)	--	--
Video Compression	H.265+/H.265 H.264+/H.264	H.264+/H.264	H.265/H.264	H.264+/H.264	H.265+/H.265 H.264+/H.264	H.265+/H.265 H.264+/H.264	H.265+/H.265 H.264+/H.264	H.265+/H.265 H.264+/H.264
Max. Resolution	1080P(1920×1080)	1080P(1920×1080)	4MP(2592×1520)	1080P(1920×1080)	1080P(1920×1080)	1080P(1920×1080)	1080P(1920×1080)	1080P(1920×1080)
Frame Rate	30fp@1080P	30fps@1080P, 60fps@720P	30fps@4MP/3MP	30fps@1080P, 60fps@720P	30fps@1080P	30fps@1080P	30fps@1080P	30fps@1080P
Multi-streaming	3 streams	3 streams	3 streams	3 streams	3 streams	3 streams	3 streams	3 streams
Pan/Tilt	Pan: 0°~360° endless Tilt: -2°~90°	Pan: 0°~360° limited Tilt: 0°~90°	Pan: 0°~355° Tilt: 0°~90°	Pan: 0°~355° Tilt: 0°~90°	Pan: 0° ~ 355° Tilt: 5° ~ 90°	Pan: 0° ~ 355° Tilt: 20° ~ 90°	Pan: 0° ~ 355° Tilt: 5° ~ 90°	Pan: 0°~355° Tilt: 20°~90°
Preset Speed	Pan: 300°/s; Tilt: 200°/s	Pan: 100°/s; Tilt: 60°/s	Pan: 100°/s; Tilt: 60°/s	Pan: 100°/s; Tilt: 60°/s	Pan: 80° /s; Tilt: 40° /s	Pan: 80° /s; Tilt: 40° /s	Pan: 80° /s; Tilt: 40° /s	Pan: 80°/s; Tilt: 40°/s
Intelligent Video	Tripwire, Intrusion Abandoned/Missing Face Detection	Tripwire, Intrusion Abandoned/Missing Face Detection	Tripwire, Intrusion Abandoned/Missing Face Detection	Tripwire, Intrusion Abandoned/Missing Face Detection	Tripwire, Intrusion Abandoned/Missing Face Detection	Tripwire, Intrusion Abandoned/Missing Face Detection	Tripwire, Intrusion Abandoned/Missing Face Detection	Tripwire, Intrusion Abandoned/Missing Face Detection
Compatibility	ONVIF profile S&G, API	ONVIF profile S&G, API	ONVIF profile S&G, API	ONVIF profile S&G, API	ONVIF profile S&G, API	ONVIF profile S&G, API	ONVIF profile S&G, API	ONVIF profile S&G, API
Audio In/Out	1/1	Built-in Mic	--	--	1(Mic in/Line in)/1	1(Mic in/Line in)/1	1(Mic in/Line in)/1	1(Mic in/Line in)/1
Memory Slot	Micro SD, Max. 256GB	Micro SD, Max. 128GB	Micro SD, Max. 256GB	Micro SD, Max. 128GB	Micro SD, Max. 256GB	Micro SD, Max. 256GB	Micro SD, Max. 256GB	Micro SD, Max. 256GB
Alarm In/Out	2/1	--	--	--	--	--	--	--
Ingress Protection	IK10	--	IP66, IK10	IP66, IK10	IP66, IK08	IP66, IK08	IP66, IK08	IP66, IK08
Working Temperature	-30°C~+60°C (-22°F~+140°F)	-30°C~+60°C (-22°F~+140°F)	-30°C~+60°C (-22°F~+140°F)	-30°C~+60°C (-22°F~+140°F)	-30°C ~ +60°C (-22°F~+140°F)	-30°C ~ +60°C (-22°F~+140°F)	-30°C ~ +60°C (-22°F~+140°F)	-30°C~+60°C (-22°F~+140°F)
Power	AC24V, PoE+(802.3at) Max. 12W	DC12V, PoE(802.3af) Max. 13W	DC12V, PoE(802.3af) Max. 10W	DC12V, PoE(802.3af) Max. 10W	DC12V, PoE(802.3af) Max. 10.5W	DC12V, PoE(802.3af) Max. 10.5W	DC12V, PoE(802.3af) Max. 6W	DC12V, PoE(802.3af) Max. 6W

NETWORK PTZ CAMERAS

Wi-Fi Series

The Wi-Fi Series PTZ offers an alternative solution with Wi-Fi technology to reduce cabling and maintenance costs. The series is suitable for indoor or near-building outdoor applications.

⊕ KEY FEATURES

Compact Design

Small PTZ cameras; Can fit in a number of places

Wire-Free

Wi-Fi technology provides easy installation without cables





Powerful Zoom

Up to 25x optical zoom easily covers large areas

PFA



Improve focusing performance to a new level

Wi-Fi Series

	Outdoor IR PTZ Camera	Mini IR PTZ Camera	Mini PTZ Camera	
Model	SD49225T-HN-W	SD29204T-GN-W	SD22404T-GN-W	SD22204T-GN-W
Appearance	 H.265+ Starlight	 reddit award 2015 winner	 H.265	
Image Sensor	1/2.8" 2MP STARVIS™ CMOS	1/2.7" 2MP CMOS	1/3" 2MP CMOS	1/2.7" 2MP CMOS
Lens	4.8~120mm (25x Optical zoom)	2.7~11mm (4x Optical zoom)	2.7~11mm (4x optical zoom)	2.7~11mm (4x Optical zoom)
FOV-H	62.8°~2.6°	112.5°~30°	112.5° ~ 30°	112.5°~30°
Min. Illumination	0.005Lux/F1.6(Color) 0Lux@F1.6(IR on)	0.05Lux/F1.6(Color) 0Lux/F1.6(IR on)	0.05Lux/F1.6(Color) 0.005Lux/F1.6(B/W)	0.05Lux/F1.6(Color) 0.005Lux/F1.6(B/W)
WDR	120dB	120dB	120dB	120dB
Max. IR Distance	100m(328ft)	30m(98ft)	--	--
Video Compression	H.265+/H.265/H.264+/H.264	H.264+/H.264	H.265/H.264	H.264+/H.264
Max. Resolution	1080P(1920×1080)	1080P(1920×1080)	4M(2592×1520)	1080P(1920×1080)
Frame Rate	30fps@1080P	30fps@1080P, 60fps@720P	30fps@1080P	30fps@1080P, 60fps@720P
Multi-streaming	3 streams	3 streams	3 streams	3 streams
Pan/Tilt	Pan: 0°~360° endless Tilt: -15°~90°	Pan: 0°~360° limited Tilt: 0°~90°	Pan: 0°~355° Tilt: 0°~90°	Pan: 0°~355° Tilt: 0°~90°
Preset Speed	Pan: 240°/s, Tilt: 200°/s	Pan: 100°/s, Tilt: 60°/s	Pan: 100°/s, Tilt: 60°/s	Pan: 100°/s, Tilt: 60°/s
Intelligent Video	Tripwire, Intrusion Abandoned/Missing Face Detection	Tripwire, Intrusion Abandoned/Missing Face Detection	Tripwire, Intrusion Abandoned/Missing Face Detection	Tripwire, Intrusion Abandoned/Missing Face Detection
Compatibility	ONVIF profile S&G, API	ONVIF profile S&G, API	ONVIF profile S&G, API	ONVIF profile S&G, API
Audio In/Out	1/1	Built-in Mic	--	--
Memory Slot	Micro SD Max. 256GB	Micro SD Max. 128GB	Micro SD Max. 256GB	Micro SD Max. 128GB
Alarm In/Out	2/1	--	--	--
Wi-Fi	Wi-Fi (IEEE802.11a/b/g/n/ac) Dual-Band Wi-Fi	Wi-Fi (IEEE802.11b/g/n)	Wi-Fi (IEEE802.11b/g/n)	Wi-Fi (IEEE802.11b/g/n)
Ingress Protection	IP66	--	IP66,IK10	IP66, IK10
Working Temperature	-40°C~+70°C (-40°F~+158°F)	-30°C~+60°C (-22°F~+140°F)	-30°C~+60°C (-22°F~+140°F)	-30°C~+60°C (-22°F~+140°F)
Power	DC12V, Max. 22W	DC12V, Max. 13W	DC12V, Max. 10W	DC12V, Max. 10W

NETWORK PTZ CAMERAS

Wi-Fi Series

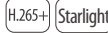
	Mini IR PTZ Camera	Mini IR PT Camera	Mini PTZ Camera	Mini PT Camera
Model	SD1A203T-GN-W	SD1A200T-GN-W	SD12203T-GN-W	SD12200T-GN-W
Appearance	 	 	 	 
Image Sensor	1/2.8" 2MP STARVIS™ CMOS	1/2.8" 2MP STARVIS™ CMOS	1/2.8" 2MP STARVIS™ CMOS	1/2.8" 2MP STARVIS™ CMOS
Lens	2.7~8.1mm (3x optical zoom)	2.8mm/F1.6 3.6mm/F1.6	2.7~8.1mm (3x optical zoom)	2.8mm/F1.6 3.6mm/F1.6
FOV-H	105.6° ~ 35.2°	102.9°/80.9°	105.6° ~ 35.2°	102.9°/80.9°
Min. Illumination	0.005Lux/F1.8(Color) 0Lux/F1.8(IR on)	0.005Lux/F1.6(Color) 0Lux/F1.6(IR on)	0.005Lux/F1.8(Color) 0.0005Lux/F1.8(B/W)	0.005Lux/F1.6(Color) 0.0005Lux/F1.6(B/W)
WDR	120dB	120dB	120dB	120dB
Max. IR Distance	15m(49ft)	15m(49ft)	--	--
Video Compression	H.265+/H.265/H.264+/H.264	H.265+/H.265/H.264+/H.264	H.265+/H.265/H.264+/H.264	H.265+/H.265/H.264+/H.264
Max. Resolution	1080P(1920×1080)	1080P(1920×1080)	1080P(1920×1080)	1080P(1920×1080)
Frame Rate	30fps@1080P	30fps@1080P	30fps@1080P	30fps@1080P
Multi-streaming	3 streams	3 streams	3 streams	3 streams
Pan/Tilt	Pan: 0° ~ 355°, Tilt: 5° ~ 90°	Pan: 0° ~ 355°, Tilt: 20° ~ 90°	Pan: 0° ~ 355°, Tilt: 5° ~ 90°	Pan: 0°~355°, Tilt: 20°~90°
Preset Speed	Pan: 80° /s, Tilt: 40° /s	Pan: 80° /s, Tilt: 40° /s	Pan: 80° /s, Tilt: 40° /s	Pan: 80°/s, Tilt: 40°/s
Intelligent Video	Tripwire, Intrusion Abandoned/Missing Face Detection	Tripwire, Intrusion Abandoned/Missing Face Detection	Tripwire, Intrusion Abandoned/Missing Face Detection	Tripwire, Intrusion Abandoned/Missing Face Detection
Compatibility	ONVIF profile S&G, API	ONVIF profile S&G, API	ONVIF profile S&G, API	ONVIF profile S&G, API
Audio In/Out	1(Mic in/Line in)/1	1(Mic in/Line in)/1	1(Mic in/Line in)/1	1(Mic in/Line in)/1
Memory Slot	Micro SD Max. 256GB	Micro SD Max. 256GB	Micro SD Max. 256GB	Micro SD Max. 256GB
Alarm In/Out	--	--	--	--
Wi-Fi	Wi-Fi (IEEE802.11a/b/g/n/ac) Dual-Band Wi-Fi	Wi-Fi (IEEE802.11a/b/g/n/ac) Dual-Band Wi-Fi	Wi-Fi (IEEE802.11a/b/g/n/ac) Dual-Band Wi-Fi	Wi-Fi (IEEE802.11a/b/g/n/ac) Dual-Band Wi-Fi
Ingress Protection	IP66,IK08	IP66,IK08	IP66,IK08	IP66,IK08
Working Temperature	-30°C ~ +60°C (-22°F~+140°F)	-30°C ~ +60°C (-22°F~+140°F)	-30°C ~ +60°C (-22°F~+140°F)	-30°C~+60°C (-22°F~+140°F)
Power	DC12V, Max. 10.5W	DC12V, Max. 10.5W	DC12V, Max. 6W	DC12V, Max. 6W

NETWORK PTZ CAMERAS

All-environment Series

All-environment series is designed for projects with the highest performance requirements and special requirements such as explosive and corrosive environment surveillance. Most of these models can be mounted upright (some of them can be mounted both upright and inverted).

⊕ KEY FEATURES

Automated Surveillance

Intelligent auto-tracking PTZ tracks suspicious objects

Superior Image

Starlight / Ultra WDR provides clear image under any light conditions

Powerful Zoom

25x / 30x / 40x / 48x optical zoom easily covers large areas

Super IR Range

Cameras provide up to 1200m IR range for performance even in dark environments

PFA

Improve focusing performance to a new level

All-environment Series

RoboPTZ Series IR Positioning System

Model	PTZ19245U-IRB-N(-B)	PTZ19240V-IRB-N(-B)
Appearance	 	 
Image Sensor	1/2.8" 2MP STARVIS™ CMOS	1/2.8" 2MP STARVIS™ CMOS
Lens	3.95~177.7mm (45x Optical zoom)	4.5~180mm (40x Optical zoom)
FOV-H	70.3°~1.8°	67.5° ~ 1.7°
Min. Illumination	0.005Lux/F1.6(Color), 0Lux/F1.6 (IR on)	0.005Lux/F1.2(Color), 0Lux/F1.2 (IR on)
WDR	120dB	140dB
Max. IR Distance	350m(1148ft)	350m(1148ft)
Video Compression	H.265+/H.265/H.264+/H.264	H.265+/H.265/H.264+/H.264
Max. Resolution	1080P(1920×1080)	1080P(1920×1080)
Frame Rate	60fps@1080P	60fps@1080P
Multi-streaming	3 streams	3 streams
Pan/Tilt	Pan: 0° ~ 360° endless Tilt: 0° ~ 360° endless(Effective angle:-55°~+223°)	Pan: 0° ~ 360° endless Tilt: 0° ~ 360° endless(Effective angle:-55°~+223°)
Preset Speed	Pan: 200° /s; Tilt: 120° /s	Pan: 200° /s; Tilt: 120° /s
Auto Tracking	Supported	Supported
Intelligent Video	Tripwire, Intrusion Abandoned/Missing Face Detection	Tripwire, Intrusion Abandoned/Missing Face Detection
Compatibility	ONVIF profile S&G, API	ONVIF profile S&G, API
Audio In/Out	1/1	1/1
Memory Slot	Micro SD, Max. 256GB	Micro SD, Max. 256GB
Alarm In/Out	7/2	7/2
Ingress Protection	IP68	IP68
Working Temperature	-50°C~+70°C(-58°F~+158°F) -40°C~+70°C(-40°F~+158°F)(-B Model)	-50°C~+70°C(-58°F~+158°F) -40°C~+70°C(-40°F~+158°F)(-B Model)
Power	AC24V: Max. 80W AC24V(-B Model), Hi-PoE: Max. 40W	AC24V: Max. 80W AC24V(-B Model), Hi-PoE: Max. 40W

NETWORK PTZ CAMERAS

All-environment Series

	RoboPTZ Series IR Positioning System	IR Positioning System		Laser Positioning System	
Model	PTZ1A225U-IRA-N	PTZ12248V-IRB-N	PTZ12230F-IRB-N	PTZ12248V-LR8-N	PTZ12230F-LR8-N
Appearance	 	 	 	 	 
Image Sensor	1/2.8" 2MP STARVIS™ CMOS	1/1.9" 2MP CMOS	1/1.9" 2MP CMOS	1/1.9" 2MP CMOS	1/1.9" 2MP CMOS
Lens	4.8~120mm(25x Optical zoom)	5.7~275mm(48x Optical zoom)	6~180mm(30x Optical zoom)	5.7~275mm(48x Optical zoom)	6~180mm(30x Optical zoom)
FOV-H	62.8°~2.6°	64.6°~1.5°	61.2°~2.1°	64.6°~1.5°	61.2°~2.1°
Min. Illumination	0.005Lux/F1.6(Color) 0Lux/F1.6(IR on)	0.001Lux/F1.4(Color) 0Lux/F1.4(IR on)	0.002Lux/F1.5(Color) 0Lux/F1.5(IR on)	0.001Lux/F1.4(Color) 0Lux/F1.4(IR on)	0.002Lux/F1.5(Color) 0Lux/F1.5(IR on)
WDR	120dB	120dB	120dB	120dB	120dB
Max. IR Distance	150m(492ft)	450m(1476ft)	300m(984ft)	1200m(3937ft)	800m(2625ft)
Video Compression	H.265+/H.265/H.264+/H.264	H.265+/H.265/H.264+/H.264	H.264	H.265+/H.265/H.264+/H.264	H.264
Max. Resolution	1080P(1920×1080)	1080P(1920×1080)	1080P(1920×1080)	1080P(1920×1080)	1080P(1920×1080)
Frame Rate	60fps@1080P	60fps@1080P	30fps@1080P, 60fps@720P	60fps@1080P	30fps@1080P, 60fps@720P
Multi-streaming	3 streams	3 streams	3 streams	3 streams	3 streams
Pan/Tilt	Pan: 0°~360° endless Tilt: -90°~90° (Effective angle: -51°~+90°)	Pan: 0°~360° endless Tilt: -90°~45°	Pan: 0°~360° endless Tilt: -90°~45°	Pan: 0°~360° endless Tilt: -90°~45°	Pan: 0°~360° endless Tilt: -90°~45°
Preset Speed	Pan: 180°/s, Tilt: 120°/s	Pan: 160°/s, Tilt: 60°/s	Pan: 160°/s, Tilt: 60°/s	Pan: 160°/s, Tilt: 60°/s	Pan: 160°/s, Tilt: 60°/s
Auto Tracking	Supported	Supported	Supported	Supported	Supported
Intelligent Video	Tripwire, Intrusion Abandoned/Missing Face Detection	Tripwire, Intrusion Abandoned/Missing Face Detection	Tripwire, Intrusion Abandoned/Missing Face Detection	Tripwire, Intrusion Abandoned/Missing Face Detection	Tripwire, Intrusion Abandoned/Missing Face Detection
Compatibility	ONVIF profile S&G, API	ONVIF profile S&G, API	ONVIF profile S&G, API	ONVIF profile S&G, API	ONVIF profile S&G, API
Audio In/Out	1/1	1/1	1/1	1/1	1/1
Memory Slot	Micro SD, Max. 256GB	Micro SD, Max. 256GB	Micro SD, Max. 128GB	Micro SD, Max. 256GB	Micro SD, Max. 128GB
Alarm In/Out	2/1	7/2	7/2	7/2	7/2
Ingress Protection	IP67, IK10	IP66	IP66	IP66	IP66
Working Temperature	-40°C~+70°C(-40°F~+158°F)	-40°C~+70°C(-40°F~+158°F)	-40°C~+70°C(-40°F~+158°F)	-40°C~+70°C(-40°F~+158°F)	-40°C~+70°C(-40°F~+158°F)
Power	DC12V, PoE+(802.3at) Max. 22W	AC24V Max. 80W	AC24V Max. 75W	AC24V Max. 90W	AC24V Max. 90W

NETWORK PTZ CAMERAS

All-environment Series

	Anti-corrosion PTZ Camera	Anti-corrosion Camera		Explosion-proof Camera
Model	SD60230U-HNI-SL	SDZW2030U-SL	SDZW2000T-SL	EPC230U
Appearance	 	 	 	 
Image Sensor	1/2.8" 2MP STARVIS™ CMOS	1/2.8" 2MP STARVIS™ CMOS	1/2.8" 2MP STARVIS™ CMOS	1/2.8" 2MP STARVIS™ CMOS
Lens	4.5~135mm (30x Optical zoom)	4.5~135mm (30x Optical zoom)	3.6mm/F2.1 6mm/F2.0	4.5~135mm (30x Optical zoom)
FOV-H	67.8° ~ 2.4°	67.8° ~ 2.4°	87° / 51°	67.8° ~ 2.4°
Min. Illumination	0.005Lux/F1.6(Color) 0.0005Lux/F1.6(B/W)	0.005Lux/F1.6(Color) 0Lux/F1.6 (IR on)	0.005Lux/F2.1(Color) 0Lux/F2.1(IR on)	0.005Lux/F1.6(Color) 0Lux/F1.6 (IR on)
WDR	120dB	120dB	120dB	120dB
Max. IR Distance	--	100m (328ft)	30m (98ft)	100m (328ft)
Video Compression	H.265+/H.265/H.264+/H.264	H.265+/H.265/H.264+/H.264	H.265+/H.265/H.264+/H.264	H.265+/H.265/H.264+/H.264
Max. Resolution	1080P(1920×1080)	1080P(1920×1080)	1080P(1920×1080)	1080P(1920×1080)
Frame Rate	60fp@1080P	60fp@1080P	60fp@1080P	60fp@1080P
Multi-streaming	3 streams	3 streams	3 streams	3 streams
Pan/Tilt	Pan: 0° ~ 360° endless Tilt: -20° ~ 90°	--	--	--
Preset Speed	Pan: 600° /s; Tilt: 500° /s	--	--	--
Auto Tracking	Supported	--	--	--
Intelligent Video	Tripwire, Intrusion Abandoned/Missing Face detection	Tripwire, Intrusion Abandoned/Missing Face detection	Tripwire, Intrusion Abandoned/Missing Face detection	Tripwire, Intrusion Abandoned/Missing Face detection
Compatibility	ONVIF profile S&G, API	ONVIF profile S&G, API	ONVIF profile S&G, API	ONVIF profile S&G, API
Audio In/Out	1/1	1/1	--	1/1
Memory Slot	Micro SD, Max. 256GB	Micro SD, Max. 256GB	--	Micro SD, Max. 256GB
Alarm In/Out	7/2	2/2	--	2/1
Ingress Protection	IP68, IK10	IP68	IP68, IK10	IP68
Working Temperature	-40°C ~ +70°C(-40°F~+158°F)	-40°C ~ +70°C(-40°F~+158°F)	-40°C ~ +60°C(-40°F~+140°F)	-40°C ~ +60°C(-40°F~+140°F)
Power	AC24V, PoE+(802.3at) Max. 20W	AC24V, DC12V, PoE+(802.3at) Max. 25W	DC12V, PoE(802.3af) Max. 5W	AC220V, Hi-PoE Max. 25W

NETWORK VIDEO RECORDERS



NETWORK VIDEO RECORDERS

Ultra Series

The Ultra Series is an ideal option for applications which require top-level performance and the highest reliability. A multi-core CPU and redundant design ensures stability while advanced intelligent features provide complex applications with intelligent video analytics.

⊕ KEY FEATURES

Powerful Processor
Multi-core Intel CPU provides high-performance processing

Industrial Design
High quality redundant-enabled design ensures high reliability and data safety

Rich Features
Fisheye dewarp, POS, ANPR (optional), N+M fail-over

Advanced Intelligence
IVS and Face Detection ensure efficient surveillance

Ultra Series

24HDD Ultra NVR				
Model	NVR724DR-256	NVR724R-256	NVR724D-256	NVR724-256
Appearance				
Processor	Intel Quad Core CPU	Intel Quad Core CPU	Intel Quad Core CPU	Intel Quad Core CPU
Video Compression	H.264/MJPEG	H.264/MJPEG	H.264/MJPEG	H.264/MJPEG
IP Video Inputs	256 channel	256 channel	256 channel	256 channel
Max Input/Record	512Mbps/512Mbps	512Mbps/512Mbps	512Mbps/512Mbps	512Mbps/512Mbps
Max Decoding	20ch@1080P (Optional: 52ch@1080P)	20ch@1080P (Optional: 52ch@1080P)	20ch@1080P (Optional: 52ch@1080P)	20ch@1080P (Optional: 52ch@1080P)
Display	2HDMI(Optional: 10HDMI) VGA, LCD	2HDMI(Optional: 10HDMI) VGA	2HDMI(Optional: 10HDMI) VGA, LCD	2HDMI(Optional: 10HDMI) VGA
Max HDD	24x8TB	24x8TB	24x8TB	24x8TB
RAID	0/1/5/10	0/1/5/10	0/1/5/10	0/1/5/10
eSATA/Mini SAS	1/2	1/2	1/2	1/2
Audio In/Out	1/1, 2-way	1/1, 2-way	1/1, 2-way	1/1, 2-way
Alarm In/Out	4/4	4/4	4/4	4/4
Ethernet	4 Gigabit Ports	4 Gigabit Ports	4 Gigabit Ports	4 Gigabit Ports
PoE	--	--	--	--
USB	2 USB3.0, 2 USB2.0	2 USB3.0, 2 USB2.0	2 USB3.0, 2 USB2.0	2 USB3.0, 2 USB2.0
Power	AC100V~240V, Redundant <200W(Without HDD)	AC100V~240V, Redundant <200W(Without HDD)	AC100V~240V <200W(Without HDD)	AC100V~240V <200W(Without HDD)
Intelligent Video	Tripwire, Intrusion Abandoned/Missing Scene Change Face Detection	Tripwire, Intrusion Abandoned/Missing Scene Change Face Detection	Tripwire, Intrusion Abandoned/Missing Scene Change Face Detection	Tripwire, Intrusion Abandoned/Missing Scene Change Face Detection
Star Features	N+M	N+M	N+M	N+M

NETWORK VIDEO RECORDERS

NETWORK VIDEO RECORDER

Ultra Series

16HDD Ultra 4K & H.265 NVR

Model	NVR616DR-128-4KS2	NVR616R-128-4KS2	NVR616D-128-4KS2	NVR616-128-4KS2	NVR616DR-64-4KS2	NVR616R-64-4KS2	NVR616D-64-4KS2	NVR616-64-4KS2
Appearance	 	 	 	 	 	 	 	 
Processor	Intel Quad Core CPU	Intel Quad Core CPU	Intel Quad Core CPU	Intel Quad Core CPU	Intel Quad Core CPU	Intel Quad Core CPU	Intel Quad Core CPU	Intel Quad Core CPU
Video Compression	H.265/H.264/MJPEG	H.265/H.264/MJPEG	H.265/H.264/MJPEG	H.265/H.264/MJPEG	H.265/H.264/MJPEG	H.265/H.264/MJPEG	H.265/H.264/MJPEG	H.265/H.264/MJPEG
IP Video Inputs	128 channel	128 channel	128 channel	128 channel	64 channel	64 channel	64 channel	64 channel
Max Input/Record	384Mbps/384Mbps	384Mbps/384Mbps	384Mbps/384Mbps	384Mbps/384Mbps	384Mbps/384Mbps	384Mbps/384Mbps	384Mbps/384Mbps	384Mbps/384Mbps
Max Decoding	4ch@8MP/16ch@1080P	4ch@8MP/16ch@1080P	4ch@8MP/16ch@1080P	4ch@8MP/16ch@1080P	4ch@8MP/16ch@1080P	4ch@8MP/16ch@1080P	4ch@8MP/16ch@1080P	4ch@8MP/16ch@1080P
Display	2HDMI(Optional: 6HDMI) VGA, LCD	2HDMI(Optional: 6HDMI) VGA	2HDMI(Optional: 6HDMI) VGA, LCD	2HDMI(Optional: 6HDMI) VGA	2HDMI(Optional: 6HDMI) VGA, LCD	2HDMI(Optional: 6HDMI) VGA	2HDMI(Optional: 6HDMI) VGA, LCD	2HDMI(Optional: 6HDMI) VGA
Max HDD	16x8TB	16x8TB	16x8TB	16x8TB	16x8TB	16x8TB	16x8TB	16x8TB
RAID	0/1/5/10	0/1/5/10	0/1/5/10	0/1/5/10	0/1/5/10	0/1/5/10	0/1/5/10	0/1/5/10
eSATA/Mini SAS	1/1	1/1	1/1	1/1	1/1	1/1	1/1	1/1
Audio In/Out	1/1, 2-way	1/1, 2-way	1/1, 2-way	1/1, 2-way	1/1, 2-way	1/1, 2-way	1/1, 2-way	1/1, 2-way
Alarm In/Out	16/8	16/8	16/8	16/8	16/8	16/8	16/8	16/8
Ethernet	4 Gigabit Ports 2 Gigabit Fiber Optical Interface	4 Gigabit Ports 2 Gigabit Fiber Optical Interface	4 Gigabit Ports 2 Gigabit Fiber Optical Interface	4 Gigabit Ports 2 Gigabit Fiber Optical Interface	4 Gigabit Ports 2 Gigabit Fiber Optical Interface	4 Gigabit Ports 2 Gigabit Fiber Optical Interface	4 Gigabit Ports 2 Gigabit Fiber Optical Interface	4 Gigabit Ports 2 Gigabit Fiber Optical Interface
PoE	--	--	--	--	--	--	--	--
USB	2 USB3.0, 2 USB2.0	2 USB3.0, 2 USB2.0	2 USB3.0, 2 USB2.0	2 USB3.0, 2 USB2.0	2 USB3.0, 2 USB2.0	2 USB3.0, 2 USB2.0	2 USB3.0, 2 USB2.0	2 USB3.0, 2 USB2.0
Power	AC100V~240V, Redundant <60W(Without HDD)	AC100V~240V, Redundant <60W(Without HDD)	AC100V~240V <60W(Without HDD)	AC100V~240V <60W(Without HDD)	AC100V~240V, Redundant <60W(Without HDD)	AC100V~240V, Redundant <60W(Without HDD)	AC100V~240V <60W(Without HDD)	AC100V~240V <60W(Without HDD)
Intelligent Video	Tripwire, Intrusion Abandoned/Missing Scene Change Face Detection People Counting, Heat Map	Tripwire, Intrusion Abandoned/Missing Scene Change Face Detection People Counting, Heat Map	Tripwire, Intrusion Abandoned/Missing Scene Change Face Detection People Counting, Heat Map	Tripwire, Intrusion Abandoned/Missing Scene Change Face Detection People Counting, Heat Map	Tripwire, Intrusion Abandoned/Missing Scene Change Face Detection People Counting, Heat Map	Tripwire, Intrusion Abandoned/Missing Scene Change Face Detection People Counting, Heat Map	Tripwire, Intrusion Abandoned/Missing Scene Change Face Detection People Counting, Heat Map	Tripwire, Intrusion Abandoned/Missing Scene Change Face Detection People Counting, Heat Map
Star Features	Fisheye Dewarp Smart Track POS, ANPR(Optional), N+M	Fisheye Dewarp Smart Track POS, ANPR(Optional), N+M	Fisheye Dewarp Smart Track POS, ANPR(Optional), N+M	Fisheye Dewarp Smart Track POS, ANPR(Optional), N+M	Fisheye Dewarp Smart Track POS, ANPR(Optional), N+M	Fisheye Dewarp Smart Track POS, ANPR(Optional), N+M	Fisheye Dewarp Smart Track POS, ANPR(Optional), N+M	Fisheye Dewarp Smart Track POS, ANPR(Optional), N+M

NETWORK VIDEO RECORDER

Ultra Series

8HDD Ultra 4K&H.265 NVR

Model	NVR608R-128-4KS2	NVR608-128-4KS2	NVR608R-64-4KS2	NVR608-64-4KS2	NVR608-32-4KS2
Appearance	 	 	 	 	 
Processor	Intel Quad Core CPU	Intel Quad Core CPU	Intel Quad Core CPU	Intel Quad Core CPU	Intel Dual Core CPU
Video Compression	H.265/H.264/MJPEG	H.265/H.264/MJPEG	H.265/H.264/MJPEG	H.265/H.264/MJPEG	H.265/H.264/MJPEG
IP Video Inputs	128 channel	128 channel	64 channel	64 channel	32 channel
Max Input/Record	384Mbps/384Mbps	384Mbps/384Mbps	384Mbps/384Mbps	384Mbps/384Mbps	384Mbps/384Mbps
Max Decoding	4ch@8MP/16ch@1080P	4ch@8MP/16ch@1080P	4ch@8MP/16ch@1080P	4ch@8MP/16ch@1080P	4ch@8MP/16ch@1080P
Display	2HDMI, VGA	2HDMI, VGA	2HDMI, VGA	2HDMI, VGA	2HDMI, VGA
Max HDD	8x8TB	8x8TB	8x8TB	8x8TB	8x8TB
RAID	0/1/5/10	0/1/5/10	0/1/5/10	0/1/5/10	0/1/5/10
eSATA/Mini SAS	1/-	1/-	1/-	1/-	1/-
Audio In/Out	1/1, 2-way	1/1, 2-way	1/1, 2-way	1/1, 2-way	1/1, 2-way
Alarm In/Out	16/8	16/8	16/8	16/8	16/8
Ethernet	2 Gigabit Ports	2 Gigabit Ports	2 Gigabit Ports	2 Gigabit Ports	2 Gigabit Ports
PoE	--	--	--	--	--
USB	2 USB3.0, 2 USB2.0	2 USB3.0, 2 USB2.0	2 USB3.0, 2 USB2.0	2 USB3.0, 2 USB2.0	2 USB3.0, 2 USB2.0
Power	AC100V~240V, Redundant <20W(Without HDD)	AC100V~240V <20W(Without HDD)	AC100V~240V, Redundant <20W(Without HDD)	AC100V~240V <20W(Without HDD)	AC100V~240V <20W(Without HDD)
Intelligent Video	Tripwire, Intrusion Abandoned/Missing Scene Change, Face Detection People Counting, Heat Map	Tripwire, Intrusion Abandoned/Missing Scene Change, Face Detection People Counting, Heat Map	Tripwire, Intrusion Abandoned/Missing Scene Change, Face Detection People Counting, Heat Map	Tripwire, Intrusion Abandoned/Missing Scene Change, Face Detection People Counting, Heat Map	Tripwire, Intrusion Abandoned/Missing Scene Change, Face Detection People Counting, Heat Map
Star Features	Fisheye Dewarp, Smart Track POS, ANPR(Optional), N+M	Fisheye Dewarp, Smart Track POS, ANPR(Optional), N+M	Fisheye Dewarp, Smart Track POS, ANPR(Optional), N+M	Fisheye Dewarp, Smart Track POS, ANPR(Optional), N+M	Fisheye Dewarp, Smart Track POS, ANPR(Optional), N+M

NETWORK VIDEO RECORDER

NETWORK VIDEO RECORDERS

Pro Series

The Pro Series is a perfect choice for mid to large-scale business and projects where both high reliability and flexibility are required. Innovative H.265+ encoding technology and special features such as fisheye dewarp, ANPR, and POS further enhance surveillance monitoring.

⊕ KEY FEATURES

Powerful Processor

ARM Cortex A17 quad-core CPU delivers 4ch@4K / 16ch@1080P

H.265+

Advanced encoding saves up to 70% bandwidth and storage

Rich Features

Fisheye dewarp, POS, ANPR, P2P

Advanced Intelligence

IVS and Face Detection ensure efficient surveillance

Pro Series

8HDD Professional 4K&H.265 NVR





Model	NVR5832-4KS2	NVR5816-4KS2	NVR5816-16P-4KS2E
Appearance	 V2.00 H.265+	 V2.00 H.265+	 ePoE H.265+
Processor	ARM Quad Core CPU	ARM Quad Core CPU	ARM Quad Core CPU
Video Compression	H.265+/H.265/H.264+/H.264	H.265+/H.265/H.264+/H.264	H.265+/H.265/H.264+/H.264
IP Video Inputs	32 channel	16 channel	16 channel
Max Input/Record	320Mbps/320Mbps	320Mbps/320Mbps	320Mbps/320Mbps
Max Decoding	4ch@8MP/16ch@1080P	4ch@8MP/16ch@1080P	4ch@8MP/16ch@1080P
Display	2HDMI, 2VGA	2HDMI, 2VGA	2HDMI, 2VGA
Max HDD	8×10TB	8×10TB	8×10TB
RAID	--	--	--
eSATA/Mini SAS	1/-	1/-	1/-
Audio In/Out	1/2, 2-way	1/2, 2-way	1/2, 2-way
Alarm In/Out	16/6	16/6	16/6
Ethernet	2 Gigabit Ports	2 Gigabit Ports	1 Gigabit Port
PoE	--	--	16 Ports (IEEE802.3at/af), 150W 1-8 PoE ports for ePoE&EoC
USB	2 USB3.0, 2 USB2.0	2 USB3.0, 2 USB2.0	2 USB3.0, 2 USB2.0
Power	AC100V~240V <16.7W(Without HDD)	AC100V~240V <16.7W(Without HDD)	AC100V~240V <17.5W(Without HDD)
Intelligent Video	Tripwire, Intrusion Abandoned/Missing Scene Change, Face Detection People Counting, Heat Map	Tripwire, Intrusion Abandoned/Missing Scene Change, Face Detection People Counting, Heat Map	Tripwire, Intrusion Abandoned/Missing Scene Change, Face Detection People Counting, Heat Map
Star Features	Fisheye Dewarp, ANPR POS, P2P	Fisheye Dewarp, ANPR POS, P2P	Fisheye Dewarp, ANPR POS, P2P, Plug & Play

NETWORK VIDEO RECORDERS

Pro Series

4HDD Professional 4K & H.265 NVR

2HDD Professional 4K & H.265 NVR

Model	NVR5432-4KS2	NVR5416-4KS2	NVR5424-24P-4KS2	NVR5416-16P-4KS2E	NVR5232-4KS2
Appearance	 V2.00 H.265+	 V2.00 H.265+	 H.265+	 ePoE H.265+	 V2.00 H.265+
Processor	ARM Quad Core CPU	ARM Quad Core CPU	ARM Quad Core CPU	ARM Quad Core CPU	ARM Quad Core CPU
Video Compression	H.265+/H.265/H.264+/H.264	H.265+/H.265/H.264+/H.264	H.265+/H.265/H.264+/H.264	H.265+/H.265/H.264+/H.264	H.265+/H.265/H.264+/H.264
IP Video Inputs	32 channel	16 channel	24 channel	16 channel	32 channel
Max Input/Record	320Mbps/320Mbps	320Mbps/320Mbps	320Mbps/320Mbps	320Mbps/320Mbps	320Mbps/320Mbps
Max Decoding	4ch@8MP/16ch@1080P	4ch@8MP/16ch@1080P	4ch@8MP/16ch@1080P	4ch@8MP/16ch@1080P	4ch@8MP/16ch@1080P
Display	2HDMI, 2VGA	2HDMI, 2VGA	2HDMI, VGA	2HDMI, 2VGA	HDMI, VGA
Max HDD	4x10TB	4x10TB	4x10TB	4x10TB	2x10TB
RAID	--	--	--	--	--
eSATA/Mini SAS	1/-	1/-	1/-	1/-	--
Audio In/Out	1/2, 2-way	1/2, 2-way	1/1, 2-way	1/2, 2-way	1/1, 2-way
Alarm In/Out	16/6	16/6	16/6	16/6	4/2
Ethernet	2 Gigabit Ports	2 Gigabit Ports	1 Gigabit Port	1 Gigabit Port	1 Gigabit Port
PoE	--	--	24 Ports (IEEE802.3at/af) 210W	16 Ports (IEEE802.3at/af), 150W 1-8 PoE ports for ePoE&EoC	--
USB	2 USB3.0, 1 USB2.0	2 USB3.0, 1 USB2.0	2 USB3.0, 1 USB2.0	2 USB3.0, 1 USB2.0	1 USB3.0, 1 USB2.0
Power	AC100V~240V <16.7W(Without HDD)	AC100V~240V <16.7W(Without HDD)	AC100V~240V <18W(Without HDD)	AC100V~240V <17.5W(Without HDD)	DC12V/4A <9.5W(Without HDD)
Intelligent Video	Tripwire, Intrusion Abandoned/Missing Scene Change, Face Detection People Counting, Heat Map	Tripwire, Intrusion Abandoned/Missing Scene Change, Face Detection People Counting, Heat Map	Tripwire, Intrusion Abandoned/Missing Scene Change, Face Detection People Counting, Heat Map	Tripwire, Intrusion Abandoned/Missing Scene Change, Face Detection People Counting, Heat Map	Tripwire, Intrusion Abandoned/Missing Scene Change, Face Detection People Counting, Heat Map
Star Features	Fisheye Dewarp, ANPR, POS, P2P	Fisheye Dewarp, ANPR, POS, P2P	Fisheye Dewarp, ANPR, POS, P2P Plug & Play	Fisheye Dewarp, ANPR, POS, P2P Plug & Play	Fisheye Dewarp, ANPR, POS, P2P

NETWORK VIDEO RECORDERS

Pro Series

2HDD Professional 4K & H.265 NVR

Model	NVR5216-4KS2	NVR5208-4KS2	NVR5224-24P-4KS2	NVR5216-16P-4KS2E	NVR5216-8P-4KS2E	NVR5208-8P-4KS2E
Appearance	 V2.00 H.265+	 V2.00 H.265+	 H.265+	 ePoE H.265+	 ePoE H.265+	 ePoE H.265+
Processor	ARM Quad Core CPU	ARM Quad Core CPU	ARM Quad Core CPU	ARM Quad Core CPU	ARM Quad Core CPU	ARM Quad Core CPU
Video Compression	H.265+/H.265/H.264+/H.264	H.265+/H.265/H.264+/H.264	H.265+/H.265/H.264+/H.264	H.265+/H.265/H.264+/H.264	H.265+/H.265/H.264+/H.264	H.265+/H.265/H.264+/H.264
IP Video Inputs	16 channel	8 channel	24 channel	16 channel	16 channel	8 channel
Max Input/Record	320Mbps/320Mbps	320Mbps/320Mbps	320Mbps/320Mbps	320Mbps/320Mbps	320Mbps/320Mbps	320Mbps/320Mbps
Max Decoding	4ch@8MP/16ch@1080P	4ch@8MP/8ch@1080P	4ch@8MP/16ch@1080P	4ch@8MP/16ch@1080P	4ch@8MP/16ch@1080P	4ch@8MP/8ch@1080P
Display	HDMI, VGA	HDMI, VGA	HDMI, VGA	HDMI, VGA	HDMI, VGA	HDMI, VGA
Max HDD	2x10TB	2x10TB	2x10TB	2x10TB	2x10TB	2x10TB
RAID	--	--	--	--	--	--
eSATA/Mini SAS	--	--	--	--	--	--
Audio In/Out	1/1, 2-way	1/1, 2-way	1/1, 2-way	1/1, 2-way	1/1, 2-way	1/1, 2-way
Alarm In/Out	4/2	4/2	4/2	4/2	4/2	4/2
Ethernet	1 Gigabit Port	1 Gigabit Port	1 Gigabit Port	1 Gigabit Port	1 Gigabit Port	1 Gigabit Port
PoE	--	--	24 Ports (IEEE802.3at/af) 210W	16 Ports (IEEE802.3at/af), 130W 1-8 PoE ports for ePoE&EoC	8 Ports (IEEE802.3at/af), 130W 1-8 PoE ports for ePoE&EoC	8 Ports (IEEE802.3at/af), 130W 1-8 PoE ports for ePoE&EoC
USB	1 USB3.0, 1 USB2.0	1 USB3.0, 1 USB2.0	1 USB3.0, 1 USB2.0	1 USB3.0, 1 USB2.0	1 USB3.0, 1 USB2.0	1 USB3.0, 1 USB2.0
Power	DC12V/4A <9.5W(Without HDD)	DC12V/4A <9.5W(Without HDD)	AC100V~240V <16W(Without HDD)	AC100V~240V <15.2W(Without HDD)	AC100V~240V <14.5W(Without HDD)	AC100V~240V <14.5W(Without HDD)
Intelligent Video	Tripwire, Intrusion Abandoned/Missing Scene Change, Face Detection People Counting, Heat Map	Tripwire, Intrusion Abandoned/Missing Scene Change, Face Detection People Counting, Heat Map	Tripwire, Intrusion Abandoned/Missing Scene Change, Face Detection People Counting, Heat Map	Tripwire, Intrusion Abandoned/Missing Scene Change, Face Detection People Counting, Heat Map	Tripwire, Intrusion Abandoned/Missing Scene Change, Face Detection People Counting, Heat Map	Tripwire, Intrusion Abandoned/Missing Scene Change, Face Detection People Counting, Heat Map
Star Features	Fisheye Dewarp, ANPR, POS, P2P	Fisheye Dewarp, ANPR, POS, P2P	Fisheye Dewarp, ANPR, POS, P2P Plug & Play	Fisheye Dewarp, ANPR, POS, P2P Plug & Play	Fisheye Dewarp, ANPR, POS, P2P Plug & Play	Fisheye Dewarp, ANPR, POS, P2P Plug & Play

NETWORK VIDEO RECORDERS

Lite H.265 Series

The Lite H.265 Series is designed for best cost performance and Dahua assured quality. The range supports innovative H.265+ encoding and energy saving techniques to help save on costs.

⊕ KEY FEATURES

Green-Tech

ARM Cortex 4K processor features enhanced power-saving capabilities

H.265+

Advanced encoding saves up to 70% bandwidth and storage

Wide Selection

Full range of high, middle, and entry-level products

Easy Setup

Plug & play installation, P2P, and smart app for carefree surveillance

















Lite H.265 Series

8HDD Lite 4K & H.265 NVR

Model	NVR4832-4KS2	NVR4816-4KS2	NVR4816-16P-4KS2
Appearance	 H.265+	 H.265+	 H.265+
Processor	ARM Quad Core CPU	ARM Quad Core CPU	ARM Quad Core CPU
Video Compression	H.265+/H.265/H.264+/H.264	H.265+/H.265/H.264+/H.264	H.265+/H.265/H.264+/H.264
IP Video Inputs	32 channel	16 channel	16 channel
Max Input/Record	200Mbps/200Mbps	200Mbps/200Mbps	200Mbps/200Mbps
Max Decoding	2ch@8MP/8ch@1080P	2ch@8MP/8ch@1080P	2ch@8MP/8ch@1080P
Display	HDMI, VGA	HDMI, VGA	HDMI, VGA
Max HDD	8×6TB	8×6TB	8×6TB
RAID	--	--	--
eSATA/Mini SAS	--	--	--
Audio In/Out	1/1, 2-way	1/1, 2-way	1/1, 2-way
Alarm In/Out	16/4	16/4	16/4
Ethernet	2 Gigabit Ports	2 Gigabit Ports	1 Gigabit Port
PoE	--	--	16 Ports (IEEE802.3at/af) 150W
USB	1 USB3.0, 2 USB2.0	1 USB3.0, 2 USB2.0	1 USB3.0, 2 USB2.0
Power	AC100V~240V <12W(Without HDD)	AC100V~240V <12W(Without HDD)	AC100V~240V <14.1W(Without HDD)
Intelligent Video	Tripwire, Intrusion Abandoned/Missing Scene Change, Face Detection People Counting, Heat Map	Tripwire, Intrusion Abandoned/Missing Scene Change, Face Detection People Counting, Heat Map	Tripwire, Intrusion Abandoned/Missing Scene Change, Face Detection People Counting, Heat Map
Star Features	P2P	P2P	Plug & Play, P2P

















NETWORK VIDEO RECORDERS

Lite H.265 Series

	4HDD Lite 4K & H.265 NVR			2HDD Lite 4K & H.265 NVR					
Model	NVR4432-4KS2	NVR4416-4KS2	NVR4416-16P-4KS2	NVR4232-4KS2	NVR4216-4KS2	NVR4208-4KS2	NVR4216-16P-4KS2	NVR4208-8P-4KS2	NVR4204-P-4KS2
Appearance	 	 	 	 	 	 	 	 	 
Processor	ARM Quad Core CPU	ARM Quad Core CPU	ARM Quad Core CPU	ARM Quad Core CPU	ARM Quad Core CPU	ARM Quad Core CPU	ARM Quad Core CPU	ARM Quad Core CPU	ARM Quad Core CPU
Video Compression	H.265+/H.265 H.264+/H.264	H.265+/H.265 H.264+/H.264	H.265+/H.265 H.264+/H.264	H.265+/H.265 H.264+/H.264	H.265+/H.265 H.264+/H.264	H.265+/H.265 H.264+/H.264	H.265+/H.265 H.264+/H.264	H.265+/H.265 H.264+/H.264	H.265+/H.265 H.264+/H.264
IP Video Inputs	32 channel	16 channel	16 channel	32 channel	16 channel	8 channel	16 channel	8 channel	4 channel
Max Input/Record	200Mbps/200Mbps	200Mbps/200Mbps	200Mbps/200Mbps	200Mbps/200Mbps	200Mbps/200Mbps	200Mbps/200Mbps	200Mbps/200Mbps	200Mbps/200Mbps	200Mbps/200Mbps
Max Decoding	2ch@8MP/8ch@1080P	2ch@8MP/8ch@1080P	2ch@8MP/8ch@1080P	2ch@8MP/8ch@1080P	2ch@8MP/8ch@1080P	2ch@8MP/8ch@1080P	2ch@8MP/8ch@1080P	2ch@8MP/8ch@1080P	2ch@8MP/4ch@1080P
Display	HDMI, VGA	HDMI, VGA	HDMI, VGA	HDMI, VGA	HDMI, VGA	HDMI, VGA	HDMI, VGA	HDMI, VGA	HDMI, VGA
Max HDD	4x6TB	4x6TB	4x6TB	2x6TB	2x6TB	2x6TB	2x6TB	2x6TB	2x6TB
RAID	--	--	--	--	--	--	--	--	--
eSATA/Mini SAS	--	--	--	--	--	--	--	--	--
Audio In/Out	1/1, 2-way	1/1, 2-way	1/1, 2-way	1/1, 2-way	1/1, 2-way	1/1, 2-way	1/1, 2-way	1/1, 2-way	1/1, 2-way
Alarm In/Out	16/4	16/4	16/4	4/2	4/2	4/2	4/2	4/2	4/2
Ethernet	2 Gigabit Ports	2 Gigabit Ports	1 Gigabit Port	1 Gigabit Port	1 Gigabit Port	1 Gigabit Port	1 Gigabit Port	1 Gigabit Port	1 Gigabit Port
PoE	--	--	16 Ports (IEEE802.3at/af) 150W	--	--	--	16 Ports (IEEE802.3at/af) 130W	8 Ports (IEEE802.3at/af) 130W	4 Ports (IEEE802.3at/af) 50W
USB	1 USB3.0, 1 USB2.0	1 USB3.0, 1 USB2.0	1 USB3.0, 1 USB2.0	1 USB3.0, 1 USB2.0	1 USB3.0, 1 USB2.0	1 USB3.0, 1 USB2.0	1 USB3.0, 1 USB2.0	1 USB3.0, 1 USB2.0	1 USB3.0, 1 USB2.0
Power	AC100V~240V <11.7W(Without HDD)	AC100V~240V <11.7W(Without HDD)	AC100V~240V <13.7W(Without HDD)	DC12V/4A <6.9W(Without HDD)	DC12V/4A <6.9W(Without HDD)	DC12V/4A <6.9W(Without HDD)	AC100V~240V <13.2W(Without HDD)	AC100V~240V <9.6W(Without HDD)	DC48V/2A <9W(Without HDD)
Intelligent Video	Tripwire, Intrusion Abandoned/Missing Scene Change Face Detection People Counting Heat Map	Tripwire, Intrusion Abandoned/Missing Scene Change Face Detection People Counting Heat Map	Tripwire, Intrusion Abandoned/Missing Scene Change Face Detection People Counting Heat Map	Tripwire, Intrusion Abandoned/Missing Scene Change Face Detection People Counting Heat Map	Tripwire, Intrusion Abandoned/Missing Scene Change Face Detection People Counting Heat Map	Tripwire, Intrusion Abandoned/Missing Scene Change Face Detection People Counting Heat Map	Tripwire, Intrusion Abandoned/Missing Scene Change Face Detection People Counting Heat Map	Tripwire, Intrusion Abandoned/Missing Scene Change Face Detection People Counting Heat Map	Tripwire, Intrusion Abandoned/Missing Scene Change Face Detection People Counting Heat Map
Star Features	P2P	P2P	Plug & Play, P2P	P2P	P2P	P2P	Plug & Play, P2P	Plug & Play, P2P	Plug & Play, P2P

NETWORK VIDEO RECORDERS

Lite H.265 Series











	1HDD Lite 4K & H.265 NVR				1HDD Lite 4K & H.265 NVR			
Model	NVR4108HS-4KS2	NVR4104HS-4KS2	NVR4108HS-8P-4KS2	NVR4104HS-P-4KS2	NVR4108-4KS2	NVR4104-4KS2	NVR4108-8P-4KS2	NVR4104-P-4KS2
Appearance	 	 	 	 	 	 	 	 
Processor	ARM Quad Core CPU	ARM Quad Core CPU	ARM Quad Core CPU	ARM Quad Core CPU	ARM Quad Core CPU	ARM Quad Core CPU	ARM Quad Core CPU	ARM Quad Core CPU
Video Compression	H.265+/H.265 H.264+/H.264	H.265+/H.265 H.264+/H.264	H.265+/H.265 H.264+/H.264	H.265+/H.265 H.264+/H.264	H.265+/H.265 H.264+/H.264	H.265+/H.265 H.264+/H.264	H.265+/H.265 H.264+/H.264	H.265+/H.265 H.264+/H.264
IP Video Inputs	8 channel	4 channel	8 channel	4 channel	8 channel	4 channel	8 channel	4 channel
Max Input/Record	80Mbps/80Mbps	80Mbps/80Mbps	80Mbps/80Mbps	80Mbps/80Mbps	80Mbps/80Mbps	80Mbps/80Mbps	80Mbps/80Mbps	80Mbps/80Mbps
Max Decoding	2ch@8MP/8ch@1080P	2ch@8MP/4ch@1080P	2ch@8MP/8ch@1080P	2ch@8MP/4ch@1080P	2ch@8MP/8ch@1080P	2ch@8MP/4ch@1080P	2ch@8MP/8ch@1080P	2ch@8MP/4ch@1080P
Display	HDMI, VGA	HDMI, VGA	HDMI, VGA	HDMI, VGA	HDMI, VGA	HDMI, VGA	HDMI, VGA	HDMI, VGA
Max HDD	1×6TB	1×6TB	1×6TB	1×6TB	1×6TB	1×6TB	1×6TB	1×6TB
RAID	--	--	--	--	--	--	--	--
eSATA/Mini SAS	--	--	--	--	--	--	--	--
Audio In/Out	1/1, 2-way	1/1, 2-way	1/1, 2-way	1/1, 2-way	1/1, 2-way	1/1, 2-way	1/1, 2-way	1/1, 2-way
Alarm In/Out	--	--	--	--	--	--	--	--
Ethernet	1×100M Port	1×100M Port	1×100M Port	1×100M Port	1×100M Port	1×100M Port	1×100M Port	1×100M Port
PoE	--	--	8 Ports (IEEE802.3at/af) 80W	4 Ports (IEEE802.3at/af) 50W	--	--	8 Ports (IEEE802.3at/af) 80W	4 Ports (IEEE802.3at/af) 50W
USB	2 USB2.0	2 USB2.0	2 USB2.0	2 USB2.0	2 USB2.0	2 USB2.0	2 USB2.0	2 USB2.0
Power	DC12V/2A <6.3W(Without HDD)	DC12V/2A <6.3W(Without HDD)	DC48V/2A <8.3W(Without HDD)	DC48V/1.5A <7.5W(Without HDD)	DC12V/2A <6.3W(Without HDD)	DC12V/2A <6.3W(Without HDD)	DC48V/2A <8.3W(Without HDD)	DC48V/1.5A <7.5W(Without HDD)
Intelligent Video	Tripwire, Intrusion Abandoned/Missing Scene Change Face Detection People Counting Heat Map	Tripwire, Intrusion Abandoned/Missing Scene Change Face Detection People Counting Heat Map	Tripwire, Intrusion Abandoned/Missing Scene Change Face Detection People Counting Heat Map	Tripwire, Intrusion Abandoned/Missing Scene Change Face Detection People Counting Heat Map	Tripwire, Intrusion Abandoned/Missing Scene Change Face Detection People Counting Heat Map	Tripwire, Intrusion Abandoned/Missing Scene Change Face Detection People Counting Heat Map	Tripwire, Intrusion Abandoned/Missing Scene Change Face Detection People Counting Heat Map	Tripwire, Intrusion Abandoned/Missing Scene Change Face Detection People Counting Heat Map
Star Features	P2P	P2P	Plug & Play, P2P	Plug & Play, P2P	P2P	P2P	Plug & Play, P2P	Plug & Play, P2P

NETWORK VIDEO RECORDERS

Lite H.265 Series











2HDD Lite 4K & H.265 NVR

1HDD Lite 4K & H.265 NVR

Model	NVR2208-4KS2	NVR2204-4KS2	NVR2208-8P-4KS2	NVR2204-P-4KS2	NVR2108HS-4KS2
Appearance	 	 	 	 	 
Processor	ARM Dual Core CPU	ARM Dual Core CPU	ARM Dual Core CPU	ARM Dual Core CPU	ARM Dual Core CPU
Video Compression	H.265+/H.265/H.264+/H.264	H.265+/H.265/H.264+/H.264	H.265+/H.265/H.264+/H.264	H.265+/H.265/H.264+/H.264	H.265+/H.265/H.264+/H.264
IP Video Inputs	8 channel	4 channel	8 channel	4 channel	8 channel
Max Input/Record	80Mbps/80Mbps	80Mbps/80Mbps	80Mbps/80Mbps	80Mbps/80Mbps	80Mbps/80Mbps
Max Decoding	1ch@8MP/4ch@1080P	1ch@8MP/4ch@1080P	1ch@8MP/4ch@1080P	1ch@8MP/4ch@1080P	1ch@8MP/4ch@1080P
Display	HDMI, VGA	HDMI, VGA	HDMI, VGA	HDMI, VGA	HDMI, VGA
Max HDD	2x6TB	2x6TB	2x6TB	2x6TB	1x6TB
RAID	--	--	--	--	--
eSATA/Mini SAS	--	--	--	--	--
Audio In/Out	1/1, 2-way	1/1, 2-way	1/1, 2-way	1/1, 2-way	1/1, 2-way
Alarm In/Out	--	--	--	--	--
Ethernet	1x100M Port	1x100M Port	1x1000M Port	1x100M Port	1x100M Port
PoE	--	--	8 Ports (IEEE802.3at/af) 80W	4 Ports (IEEE802.3at/af) 50W	--
USB	2 USB2.0	2 USB2.0	2 USB2.0	2 USB2.0	2 USB2.0
Power	DC12V/4A <3W(Without HDD)	DC12V/4A <3W(Without HDD)	DC54V/2.2A <5.8W(Without HDD)	DC48V/1.5A <5.3W(Without HDD)	DC12V/2A <3W(Without HDD)
Intelligent Video	--	--	--	--	--
Star Features	P2P	P2P	Plug & Play, P2P	Plug & Play, P2P	P2P





NETWORK VIDEO RECORDERS

Lite H.265 Series

	1HDD Lite 4K & H.265 NVR			1HDD Lite 4K & H.265 NVR			
Model	NVR2104HS-4KS2	NVR2108HS-8P-4KS2	NVR2104HS-P-4KS2	NVR2108-4KS2	NVR2104-4KS2	NVR2108-8P-4KS2	NVR2104-P-4KS2
Appearance	 	 	 	 	 	 	 
Processor	ARM Dual Core CPU	ARM Dual Core CPU	ARM Dual Core CPU	ARM Dual Core CPU	ARM Dual Core CPU	ARM Dual Core CPU	ARM Dual Core CPU
Video Compression	H.265+/H.265/H.264+/H.264	H.265+/H.265/H.264+/H.264	H.265+/H.265/H.264+/H.264	H.265+/H.265/H.264+/H.264	H.265+/H.265/H.264+/H.264	H.265+/H.265/H.264+/H.264	H.265+/H.265/H.264+/H.264
IP Video Inputs	4 channel	8 channel	4 channel	8 channel	4 channel	8 channel	4 channel
Max Input/Record	80Mbps/80Mbps	80Mbps/80Mbps	80Mbps/80Mbps	80Mbps/80Mbps	80Mbps/80Mbps	80Mbps/80Mbps	80Mbps/80Mbps
Max Decoding	1ch@8MP/4ch@1080P	1ch@8MP/4ch@1080P	1ch@8MP/4ch@1080P	1ch@8MP/4ch@1080P	1ch@8MP/4ch@1080P	1ch@8MP/4ch@1080P	1ch@8MP/4ch@1080P
Display	HDMI, VGA	HDMI, VGA	HDMI, VGA	HDMI, VGA	HDMI, VGA	HDMI, VGA	HDMI, VGA
Max HDD	1×6TB	1×6TB	1×6TB	1×6TB	1×6TB	1×6TB	1×6TB
RAID	--	--	--	--	--	--	--
eSATA/Mini SAS	--	--	--	--	--	--	--
Audio In/Out	1/1, 2-way	1/1, 2-way	1/1, 2-way	1/1, 2-way	1/1, 2-way	1/1, 2-way	1/1, 2-way
Alarm In/Out	--	--	--	--	--	--	--
Ethernet	1×100M Port	1×1000M Port	1×100M Port	1×100M Port	1×100M Port	1×1000M Port	1×100M Port
PoE	--	8 Ports (IEEE802.3at/af) 80W	4 Ports (IEEE802.3at/af) 50W	--	--	8 Ports (IEEE802.3at/af) 80W	4 Ports (IEEE802.3at/af) 50W
USB	2 USB2.0	2 USB2.0	2 USB2.0	2 USB2.0	2 USB2.0	2 USB2.0	2 USB2.0
Power	DC12V/2A <3W(Without HDD)	DC48V/2A <5.8W(Without HDD)	DC48V/1.25A <5.3W(Without HDD)	DC12V/2A <3W(Without HDD)	DC12V/2A <3W(Without HDD)	DC48V/2A <5.8W(Without HDD)	DC48V/1.25A <5.3W(Without HDD)
Intelligent Video	--	--	--	--	--	--	--
Star Features	P2P	Plug & Play, P2P	Plug & Play, P2P	P2P	P2P	Plug & Play, P2P	Plug & Play, P2P

DISPLAY & CONTROL

Monitors

Model	DHL19-F600	DHL22-F600	DHI-LM24-F211	DHL49-4K	LM55-S401
Appearance					
Diagonal	19.5"(16:9)	20.7"(16:9)	23.8"(16:9)	48.5"(16:9)	55"(16:9)
Resolution	1600x900	1920x1080	1920x1080	3840x2160	3840x2160
Luminance	200cd/m ²	250cd/m ²	250cd/m ²	500cd/m ²	500cd/m ²
Contrast	1000:1	1000:1	1000:1	1100:1	4000:1
Viewing Angle	H 170°, V 160°	H 178°, V 130°	H 178°, V 178°	H 178°, V 178°	H 178°, V 178°
Response Time	5ms	5ms	14ms	8ms	7ms
Display Color	8bit	8bit	8bit	8bit	8bit
Input	1 VGA,	1 VGA, 1 HDMI 1 Audio	1 VGA, 1 HDMI 1 Audio	1 VGA, 1 CVBS, 1 DVI-D 2 HDMI, 1 USB	1 VGA, 1 CVBS, 1 DVI-D 2 HDMI, 1 RS232, 1 USB
Output	--	2 Speakers	2 Speakers	1 Audio, 1 RS232, 2 Speakers	1 Audio, 1 RS232, 2 Speakers
Control	Physical Button	Physical Button	Physical Button	RS232, Infrared Remote	RS232, Infrared Remote
Working Temperature	0°C~+40°C(+32°F~+104°F)	0°C~+40°C(+32°F~+104°F)	0°C~+40°C(+32°F~+104°F)	0°C~+50°C(+32°F~+122°F)	0°C~+50°C(+32°F~+122°F)
Working Humidity	10~85%	10~90%	10~85%	20~90%	20~90%
Power	AC100~240V(+/-10%), 25W	AC100~240V(+/-10%), 23W	AC110~240V, 29W	AC100~240V(+/-10%), 70W	AC100~240V(+/-10%), 160W
Dimensions (without base)	467.0x283.0x51.5mm (18.4"x11.1"x2.0")	490.3x292.3x48.3mm (19.3"x11.5"x1.9")	540.6x322.6x50.1mm (21.3"x12.7"x2.0")	1127.1x667.3x51.9mm (44.4"x26.3"x2.0")	1222.0x692.8x63.2mm (48.1"x27.3"x2.5")
Weight	3.8kg(8.4lb)	2.5kg(5.5lb)	3.7kg(8.2lb)	18kg(39.7lb)	20kg(44.1lb)

DISPLAY & CONTROL

Controllers	
Model	M70-D-0204HO(-H)
Appearance	
Supported Screens	2 Screens
Splicing Control	Zoom/Merge/Roam/Overlay
Max Decoding	4CH@4K/16CH@1080P/36CH@720P/64CH@D1
Network Video Input	IPC/DVR/NVR/VNC, etc.
Video Output	HDMI
Intercom	RCA(2Vrms, 10k ohms)
Processor	64 bit quad core processor
Case	1U
Ethernet	2 RJ-45 ports (10/100/1000M)
USB	1 USB2.0, 1USB3.0
Power	DC12V, 4A
Control Mode	WEB/Local menu/VMS Network keyboard/iPad
Highlights	Distributed 4K decoding Cost-efficient





Decoders			
Model	NVD0105DH-4K	NVD0905DH-4I-4K	NVD1205DH-4I-4K
Appearance			
Supported Screen	1 Screens	9 Screens	12 Screens
Splicing Control	Zoom/Merge/Roam/Overlay	Zoom/Merge/Roam/Overlay	Zoom/Merge/Roam/Overlay
Split Mode	1/4/9/16/25/36/64	1/4/9/16	1/4/9/16
Max Decoding	3CH@12MP(25fps)/4CH@4K(30fps)/16CH@1080P(30fps)/8CH@1080P(60fps)/36CH@720P(30fps)/64CH@D1(30fps)	9CH@12MP(15fps)/9CH@4K/48CH@1080P/81CH@720P/144CH@D1	12CH@12MP(15fps)/12CH@4K/48CH@1080P/108CH@720P/192CH@D1
Local Video Input	--	2CH HDMI, 2CH DVI-I	2CH HDMI, 2CH DVI-I
Network Video Input	IPC/DVR/NVR, etc.	IPC/DVR/NVR, etc.	IPC/DVR/NVR, etc.
Video Output	HDMI/VGA	HDMI(DVI with convertor)	HDMI(DVI with convertor)
Audio Out	HDMI	HDMI	HDMI
Alarm In/Out	4/4(30VDC 1A, 125VAC 0.5A, Relay output)	4/4(30VDC 1A, 125VAC 0.5A, Relay output)	2/1(30VDC 1A, 125VAC 0.5A, Relay output)
Intercom	1 Pair RCA	1 Pair 3.5mm Jack	1 Pair 3.5mm Jack
Processor	Intel x86 processor	Intel x86 processor	Embedded processor
Case	1U 19"	1.5U 19"	2.5U 19"
Ethernet	1 RJ-45 port (10/100/1000M, self-adaptive)	2 RJ-45 ports (10/100/1000M)	2 RJ-45 ports (10/100/1000M)
USB	2 USB2.0	1 USB2.0, 2 USB3.0	1 USB2.0, 2 USB3.0
Power Supply	DC12V/3.3A	AC100~240V, 50 Hz~60Hz	AC 100V~127V, 200V~240V 47Hz~63Hz
Control Mode	WEB/Local menu/Video Platform/Network keyboard	WEB/VMS/Network keyboard/iPad	WEB/VMS/Network keyboard/iPad
Highlights	4K & H.265 & H.265+ decoding, Fisheye dewarp, Support the display of intelligent regular line	4K & H.265 & H.265+ decoding, Fisheye dewarp, PC signal collection	4K & H.265 decoding, Fisheye adjustment, PC signal collection

Keyboards	
Model	NKB5000(-F)
Appearance	
Operation System	Embedded LINUX 4.2.0
Audio Input/Output	1 pair 3.5mm jack, supported bidirectional talk
Loudspeaker	1W
Alarm In	4, High-low level
Alarm Out	4 (3 relay, 1 12V_1A)
Stream Type	H.265, H.264, MPEG Nonstandard
Resolution	4CH@4K/16CH@1080P
Display split	1/4/9/16
Screen	10.1" TFT LCD touch screen (1280x800)
Joystick	4-axis(zoom, focus, iris)
Control Mode	Direct Mode, Network Mode
USB Interface	2 USB3.0, 2 USB2.0
Power	DC12V, 4A, 5W
Working Temperature	-10°C~+55°C
Working Humidity	10%~95%
Dimensions	Host: 425mm×205mm×59mm (W×D×H) (height:exclude joystick) MiniKeypad: 421.5mm×105mm×26mm (W×D×H)
Weight	<3.73kg (exclude package)

TRANSMISSION

PoE Switches

Desktop PoE Switch

Model	PFS3005-4P-58	PFS3006-4ET-60	PFS3008-8ET-60	PFS3009-8ET-96	PFS3010-8ET-96	PFS4218-16ET-190/240	PFS4226-24ET-240/360
Appearance							
Fast/Gigabit Ethernet	4FE PoE+1FE	4FE PoE+2FE	4FE PoE+4FE	8 FE PoE + 1FE	8 FE PoE + 2GE	16FE PoE+2GE (Combo)	24FE PoE+2GE (Combo)
SFP Slots	--	--	--	--	--	2GE SFP (Combo)	2GE SFP (Combo)
Switching Capacity	1Gbps	1.8Gbps	1.8Gbps	1.8Gbps	5.6Gbps	8.8Gbps	8.8Gbps
Packet Forwarding Rate	744Kpps	890Kpps	1.19Mpps	1.34Mpps	4.17Mpps	5.36Mpps	6.55Mpps
Packet Buffer Memory	448kb	768kb	768kb	768kb	4Mb	2.75Mb	2.75Mb
MAC Table Size	1K	2K	2K	2K	16K	4K	4K
PoE Standard	PoE (802.3af) PoE+ (802.3at)	PoE (802.3af) PoE+ (802.3at), Hi-PoE	PoE (802.3af) PoE+ (802.3at), Hi-PoE	PoE (802.3af) PoE+ (802.3at), Hi-PoE	PoE (802.3af) PoE+ (802.3at), Hi-PoE	PoE (802.3af) PoE+ (802.3at), Hi-PoE	PoE (802.3af) PoE+ (802.3at), Hi-PoE
PoE Budget	58W	60W	60W	96W	96W	190W/240W	240W/360W
Long Distance PoE Transmission	Yes (250 meters)	Yes (250 meters)	Yes (250 meters)	Yes (250 meters)	Yes (250 meters)	Yes (250 meters)	Yes (250 meters)
VLAN	--	--	--	--	--	Supported	Supported
Link Aggregation	--	--	--	--	--	Supported	Supported
Flow Control	Supported	Supported	Supported	Supported	Supported	Supported	Supported
Spanning Tree	--	--	--	--	--	Supported	Supported
Management	--	--	--	--	--	Web	Web
Lightning Protection	Common Mode 2KV Differential Mode 1KV	Common Mode 2KV Differential Mode 0.5KV	Common Mode 2KV Differential Mode 0.5KV	Common Mode 2KV Differential Mode 0.5KV	Common Mode 2KV Differential Mode 0.5KV	Common Mode 4KV Differential Mode 2KV	Common Mode 4KV Differential Mode 2KV
Working Temperature	-10°C~-50°C (14°F~-122°F)	-10°C~-55°C (14°F~-131°F)	-10°C~-55°C (14°F~-131°F)	-10°C~-55°C (14°F~-131°F)	-10°C~-55°C (14°F~-131°F)	-10°C~-55°C (14°F~-131°F)	-10°C~-55°C (14°F~-131°F)
Dimensions(WxDxH)	100mm×100mm×26mm (3.9"×3.9"×1.0")	130mm×85mm×26mm (5.1"×3.3"×1.0")	190mm×100mm×30mm (7.5"×3.9"×1.2")	190mm×100mm×30mm (7.5"×3.9"×1.2")	190mm×100mm×30mm (7.5"×3.9"×1.2")	440mm×300mm×44mm (17.3"×11.8"×1.7")	440mm×300mm×44mm (17.3"×11.8"×1.7")



PoE Switches

	Hardened PoE Switch				Industrial PoE Switch	
Model	PFS3106-4P-60	PFS3110-8P-96	PFS3211-8GT-120	PFS3409-4GT-96	PFS4210-8GT-DP	PFS4410-6GT-DP
Appearance						
Fast/Gigabit Ethernet	4FE PoE+1GE	8FE PoE+1GE	8GE PoE+1GE	4GE PoE+1GE	8GE PoE	6GE PoE
SFP Slots	1GE SFP	1GE SFP	2GE SFP	4GE SFP	2GE SFP	4GE SFP
Switching Capacity	6.8Gbps	7.6Gbps	33Gbps	33Gbps	28Gbps	28Gbps
Packet Forwarding Rate	3.57Mpps	4.17Mpps	16.37Mpps	13.39Mpps	14.88Mpps	14.88Mpps
Packet Buffer Memory	1Mb	1Mb	1.75Mb	1.75Mb	4Mb	4Mb
MAC Table Size	8K	8K	4K	4K	8K	8K
PoE Standard	PoE (802.3af) PoE+ (802.3at)	PoE (802.3af) PoE+ (802.3at)	PoE (802.3af) PoE+ (802.3at) Hi-PoE	PoE (802.3af) PoE+ (802.3at) Hi-PoE	PoE (802.3af) PoE+ (802.3at) Hi-PoE	PoE (802.3af) PoE+ (802.3at) Hi-PoE
PoE Budget	60W	96W	120W	96W	≤120W	≤120W
Long Distance PoE Transmission	--	--	--	--	--	--
VLAN	--	--	--	--	Supported	Supported
Link Aggregation	--	--	--	--	Supported	Supported
Flow Control	Supported	Supported	Supported	Supported	Supported	Supported
Spanning Tree	--	--	--	--	Supported	Supported
Management	--	--	--	--	Supported	Supported
Lightning Protection	Common Mode 4KV Differential Mode 2KV	Common Mode 4KV Differential Mode 2KV	Common Mode 4KV Differential Mode 2KV	Common Mode 4KV Differential Mode 2KV	Common Mode 6KV Differential Mode 4KV	Common Mode 6KV Differential Mode 4KV
Working Temperature	-30°C~+65°C (-22°F~+149°F)	-30°C~+65°C (-22°F~+149°F)	-30°C ~ +65°C (-22°F~+149°F)	-30°C ~ +65°C (-22°F~+149°F)	-40°C ~ +75°C(-40°F~+167°F)	-40°C ~ +75°C(-40°F~+167°F)
Dimensions(WxDxH)	150mm×100mm×30mm (5.9"×3.9"×1.2")	150mm×100mm×42mm (5.9"×3.9"×1.7")	150mm ×100mm×42mm (5.9"×3.9"×1.7")	150mm ×100mm ×42mm (5.9"×3.9"×1.7")	175.0mm×126.5mm×53.5mm (6.9"×5.0"×2.1")	175.0mm×126.5mm×53.5mm (6.9"×5.0"×2.1")

TRANSMISSION

PoE Switches



ePoE Switch

Model	PFL2106-4ET-96	LR2110-8ET-120	LR2218-16ET-240	LR2226-24ET-360
Appearance				
Fast/Gigabit Ethernet	4FE ePoE+ 1GE	8FE ePoE+ 1GE	8FE ePoE+ 8FE PoE+ 2GE Combo	8FE ePoE+ 16FE ePoE+ 2GE Combo
SFP Slots	1 GE SFP	1 GE SFP	2 GE SFP	2 GE SFP
Switching Capacity	6.8Gbps	8.8Gbps	8.8Gbps	8.8Gbps
Packet Forwarding Rate	3.57Mpps	4.17Mpps	5.36Mpps	6.55Mpps
Packet Buffer Memory	1Mb	2.75Mb	2.75Mb	2.75Mb
MAC Table Size	8K	4K	4K	4K
PoE Standard	PoE (802.3af) PoE+ (802.3at) Hi-PoE	PoE (802.3af) PoE+ (802.3at) Hi-PoE	PoE (802.3af) PoE+ (802.3at) Hi-PoE	PoE (802.3af) PoE+ (802.3at) Hi-PoE
PoE Budget	96W	120W	240W	360W
Long Distance PoE Transmission	Yes (800 meters)	Yes (800 meters)	Yes (800 meters)	Yes (800 meters)
VLAN	--	--	Supported	Supported
Link Aggregation	--	--	Supported	Supported
Flow Control	Supported	Supported	Supported	Supported
Spanning Tree	--	--	Supported	Supported
Management	--	--	Supported	Supported
Lightning Protection	Common Mode 4KV Differential Mode 2KV	Common Mode 4KV Differential Mode 2KV	Common Mode 4KV Differential Mode 2KV	Common Mode 4KV Differential Mode 2KV
Working Temperature	-30°C~+65°C (-22°F~+149°F)	-30°C~+65°C (-22°F~+149°F)	-10°C~+55°C (14°F~+131°F)	-10°C~+55°C (14°F~+131°F)
Dimensions(WxDxH)	150mm×100mm×30mm (5.9"×3.9"×1.2")	150mm×100mm×42mm (5.9"×3.9"×1.7")	440mm×300mm×44mm (17.3"×11.8"×1.7")	440mm×300mm×44mm (17.3"×11.8"×1.7")









TRANSMISSION

	L2+ Full Gigabit Switches		L3 Full Gigabit Switches
Model	PFS5424-24T	PFS5924-24X	PFS6428-24T
Appearance			
Fast/Gigabit Ethernet	20GE+4GE (Combo)	8GE (Combo)	24GE
SFP Slots	4GE SFP(Combo)	16GE SFP+8GE SFP(Combo)	4 GE SFP/10GE SFP+
Switching Capacity	350G	350G	392G
Packet Forwarding Rate	36Mpps	36Mpps	96Mpps
Packet Buffer Memory	32Mb	32Mb	12Mb
VLAN	Supported	Supported	Supported
Link Aggregation	Supported	Supported	Supported
Port Management	Flow Control, Speed Limit Port Mirroring	Flow Control, Speed Limit Port Mirroring	Flow Control, Speed Limit Port Mirroring
Ring Network Protocol	STP/RSTP, ERPS	STP/RSTP, ERPS	STP/RSTP, ERPS
IGMP Snooping	Supported	Supported	Supported
Static IP Routing	Supported	Supported	Supported
Dynamic Routing	--	--	OSPF, RIP, BGP
VRRP	--	--	Supported
Management	Web,CLI	Web,CLI	Web,CLI
Working Temperature	-10°C~-55°C (14°F~+131°F)	-10°C~-55°C (14°F~+131°F)	-10°C~-55°C (14°F~+131°F)
Dimensions	440×285×44.5mm (17.3"×11.2"×1.8")	440×285×44.5mm (17.3"×11.2"×1.8")	440×285×44.5mm (17.3"×11.2"×1.8")

	PoE Midspans	PoE Extenders
Model	PFT1200	PFT1300
Appearance		
Fast/Gigabit Ethernet	2GE	3FE
SFP Slots	--	--
Switching Capacity	--	1.4G
Packet Forwarding Rate	--	0.47Mpps
Packet Buffer Memory	--	512Kb
MAC Table Size	--	1K
PoE Standard	PoE (802.3af) PoE+ (802.3at), Hi-PoE	PoE (802.3af) PoE+ (802.3at)
PoE Budget	60W	--
PoE PIN Assignment	1, 2, 4, 5(V+), 3, 6, 7, 8(V-)	4, 5(V+), 7, 8(V-)
Lightning Protection	Common Mode 4KV Differential Mode 2KV	Common Mode 4KV Differential Mode 2KV
Working Temperature	-30°C~+65°C(-22°F~+149°F)	-30°C~+65°C(-22°F~+149°F)
Dimensions	150×70×39mm (5.9"×2.8"×1.5")	79×52×23mm (3.1"×2.0"×0.9")



Ethernet over Coax		
	LR1002	LR1002-1ET/LR1002-1EC
Model		
Interface	1FE+1*BNC	1FE+1*BNC
Transmission Bandwidth	RG59 coaxial cable: 400m/100 Mbps, 1000m/10 Mbps	RG59 coaxial cable: 400m/100 Mbps, 1000m/10 Mbps
PoE Standard	(Based on the power input from the ePoE switch)	PoE (802.3af) PoE+ (802.3at)
Lightning Protection	Common Mode 6KV Differential Mode 2KV	Common Mode 4KV Differential Mode 2KV
Working Temperature	-40°C~+65°C(-40°F~+149°F)	-30°C~+65°C(-22°F~+149°F)
Dimensions(WxDxH)	56mm×27mm×21mm(2.2"×1.1"×0.8")	79mm×52mm×23mm(3.1"×2.0"×0.9")



TRANSMISSION



Outdoor Wireless Transmission Device						Indoor Wireless Transmission Device		
	5G Wireless CPE		5G Wireless AP	5G Wireless Backhails		2.4G Wireless AP for Elevator	2.4G&5G Wireless Ceiling AP	
Model	PFM881	PFM881-L	PFM880	PFM886-10	PFM886-20	PFM885-I	PFM889-I	PFM889-IM
Appearance								
Fast/Gigabit Ethernet	2FE	2FE	1GE	1GE	1GE	3FE	3FE	2GE
Wireless Standard	IEEE802.11a/n	IEEE802.11a/n	IEEE802.11a/n	IEEE802.11a/n/ac	IEEE802.11a/n/ac	IEEE802.11 b/g/n	IEEE802.11 b/g/n	IEEE802.11 a/n/ac IEEE802.11 b/g/n
Working Frequency	5745~5825MHz(extended range: 4920~6100MHz)	5745~5825MHz(extended range: 4920~6100MHz)	5745~5825MHz(extended range: 4920~6100MHz)	5745~5825MHz(extended range: 4920~6100MHz)	5745~5825MHz(extended range: 4920~6100MHz)	2412~2472Mhz(extended range: 2312~2732Mhz)	2412~2472Mhz(extended range: 2312~2732Mhz)	2.4G: 2412~2472Mhz (extended range: 2312~2732Mhz) 5G: 5745~5825MHz(extended range: 4920~6100MHz)
Wireless Speed	300Mbps	300Mbps	300Mbps	867Mbps	867Mbps	300Mbps	300Mbps	2.4G: 300Mbps 5G: 867Mbps
Transmission Distance	0-3Km(0-9.8Kft)	0-1.5Km(0-4.9Kft)	0-3Km(0-9.8Kft)	0-10Km(0-32.8Kft)	0-20Km(0-65.6Kft)	0-500m(0-1640.4ft)	0-150m(0-492ft)	0-150m(0-492ft)
Antenna Gain	15dBi	12dBi	16dBi	25dBi	29dBi	6dBi	3dBi	External 2.4G: 3dBi Internal 5G: 3dBi
Polarization	Dual Linear: Horizontal 40° Vertical 15°	Dual Linear: Horizontal 35° Vertical 35°	Dual Linear: Horizontal 90° Vertical 9°	Dual Linear: Horizontal 11° Vertical 11°	Dual Linear: Horizontal 6° Vertical 6°	Dual Linear: Horizontal 65° Vertical 60°	Omni-directional	Omni-directional
Max Tx Power	27dBm	24dBm	30dBm	27dBm	27dBm	27dBm	27dBm	27dBm
Processor	MIPS 74K 560MHz	MIPS 74K 560MHz	MIPS 74K 560MHz	MIPS 74K 720MHz	MIPS 74K 720MHz	MIPS 24K 550MHz	MIPS 24K 550MHz	MIPS 74K 720MHz
Memory	64MB DDR2, 8MB Flash	64MB DDR2, 8MB Flash	64MB DDR2, 8MB Flash	128MB DDR2, 16MB Flash	128MB DDR2, 16MB Flash	64MB DRAM, 8MB Flash	64MB DRAM, 8MB Flash	64MB DDR2, 16MB Flash
Proprietary Protocol	TDMA	TDMA	TDMA	TDMA	TDMA	--	--	--
Network Security	WPA/WPA2, Hide SSID IP/MAC Filtering	WPA/WPA2, Hide SSID IP/MAC Filtering	WPA/WPA2, Hide SSID IP/MAC Filtering	WPA/WPA2, Hide SSID IP/MAC Filtering	WPA/WPA2, Hide SSID IP/MAC Filtering	WPA/WPA2, Hide SSID IP/MAC Filtering	WPA/WPA2, Hide SSID IP/MAC Filtering	WPA/WPA2, Hide SSID IP/MAC Filtering
Management	Web	Web	Web	Web	Web	Web	Web	Web
Lightning Protection	--	--	Common Mode 4KV Differential Mode 1.5KV	Common Mode 4KV Differential Mode 1.5KV	Common Mode 4KV Differential Mode 1.5KV	--	--	--
Ingress Protection	IP65	IP65	IP66	IP66	IP66	IP41	IP41	IP41
Working Temperature	-30°C~-70°C(-22°F~+158°F)	-30°C~-70°C(-22°F~+158°F)	-30°C~-70°C(-22°F~+158°F)	-30°C~-70°C(-22°F~+158°F)	-30°C~-70°C(-22°F~+158°F)	-30°C~-70°C(-22°F~+158°F)	-30°C~-60°C(-22°F~+140°F)	-30°C~-60°C(-22°F~+140°F)



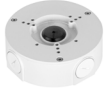

ACCESSORIES

HFxxE, HFxxF Series		
		
Model	PFB110W	PFB121W
Mount	Wall/Ceiling/Plane mount	Wall mount

HFWxxE, HFWxxE-Z Series		
		
Model	PFA121	PFA121+PFA152-E
Mount	Junction box	Pole mount

HFWxxT Series		
		
Model	PFA130-E	PFA130-E+PFA152-E
Mount	Junction box	Pole mount

HFWxxS Series		
		
Model	PFA134	PFA134+PFA152-E
Mount	Junction box	Pole mount

PFWxx Series			
			
Model	PFA120	PFA150	PFA151
Mount	Junction box	Pole mount	Corner Mount

PDBW Series		
		
Model	PFA111+PFB303W	PFA111+PFB303S
Mount	Wall mount	Parapet mount

HDBWxxE-Z Series					
					
Model	PFA138	PFB210W	PFB210W+PFA152-E	PFA101+PFB300C	PFB201C
Mount	Junction box	Wall mount	Pole mount	Ceiling mount	In-ceiling mount

ACCESSORIES

HDBWxxR-Z/VF Series						
						
Model	PFA137	PFB203W	PFB203W+PFA152-E	PFA106+PFB220C	PFB200C	PFA200W
Mount	Junction box	Wall mount	Pole mount	Ceiling mount(extensible)	In-ceiling mount	Rain shade

HDBWxxE Series				
				
Model	PFA136	PFB203W	PFB203W+PFA152-E	PFA136+PFA200W
Mount	Junction box	Wall mount	Pole mount	Rain shade

EB, HDBxxC Series			
			
Model	PFA136	PFB203W	PFB203W+PFA152-E
Mount	Junction box	Wall mount	Pole mount









HDWxxR-Z			
			
Model	PFA130-E	PFB203W	PFB203W+PFA152-E
Mount	Junction box	Wall mount	Pole mount

HDWxxEM Series			
			
Model	PFA130-E	PFB204W	PFB204W+PFA152-E
Mount	Junction box	Wall mount	Pole mount

HDWxxS Series			
			
Model	PFA130-E	PFB203W	PFB203W+PFA152-E
Mount	Junction box	Wall mount	Pole mount









HDBWxxF Series			
			
Model	PFA139	PFB204W	PFB204W+PFA152-E
Mount	Junction box	Wall mount	Pole mount

ACCESSORIES

SD65F/60/6AE/6AL Series								
								
Model	PFA111+PFB303W	PFB310W	PFA111+PFB303W+PFA120	PFA111+PFB300C	PFA150	PFA151	PFA140	PFA111+PFB303S
Mount	Wall mount		Junction box	Ceiling mount	Pole mount	Corner Mount	Power box	Parapet mount

SD6C Series								
								
Model	64FB	PFA114+PFB303W+PFA120	PFA114+PFB300C	PFA150	PFA151	PFA140	PFA114+PFB303S	
Mount	Wall mount	Junction box	Ceiling mount	Pole mount	Corner Mount	Power box	Parapet mount	

SD59/50/40 Series								
								
Model	PFA110+PFB300S	PFA110+PFB300S+PFA120	PFA110+PFB300C	PFA150	PFA151	PFA140	PFA110+PFB303S	
Mount	Wall mount	Junction box	Ceiling mount	Pole mount	Corner Mount	Power box	Parapet mount	

SD6CE/49 Series								
								
Model	PFB305W	PFB310W	PFB305W+PFA120	PFA111+PFB300C	PFA150	PFA151	PFA140	PFA111+PFB303S
Mount	Wall mount		Junction box	Ceiling mount	Pole mount	Corner Mount	Power box	Parapet mount







ACCESSORIES

SD42 Series					
					
Model	PFA102+PFB302S	PFA102+PFB302S+PFA150	PFA102+PFB302S+PFA151	PFA102+PFB300C	
Mount	Wall mount	Pole mount	Corner Mount	Ceiling mount	

SD29 Series					
 					
Model	PFA103+PFB302S	PFA103+PFB302S+PFA150	PFA103+PFB302S+PFA151	PFA103+PFB300C	
Mount	Wall mount	Pole mount	Corner Mount	Ceiling mount	









SD22 Series					
					
Model	PFA137	PFB203W	PFB203W+PFA152-E	PFB200C	
Mount	Junction box	Wall mount	Pole mount	In-ceiling mount	









SD1A/12 Series			
			
Model	PFA107+PFB305W	PFA107+PFB220C	
Mount	Wall mount	Ceiling mount (extensible)	

Housings					Power Adapters		
Model	PFH610V Series	PFH610A Series	PFH610E Series	PFH610N-IR-W	AC Power		
Appearance							
Description	Aluminum & PC N/A/Heater, cooler/Heater, cooler, IR/ Heater, cooler, IR, POE IP67, IK10 DC12V/AC24V in 404x164x132mm(15.9"x6.45"x5.2")	Aluminum & PC N/A/Heater, cooler/Heater, cooler, IR/ Heater, cooler, IR, POE IP67, IK10, NEMA 4X DC12V/AC24V in 404x164x132mm(15.9"x6.45"x5.2")	Aluminum & PC Heater, cooler/Heater, cooler, IR IP67, IK10, NEMA 4X AC110/220 in 404x164x132mm(15.9"x6.45"x5.2") -65°C~+55°C	Aluminum & PC Heater, cooler, wiper, IR IP66 AC24V, 5A in 404x164x175mm (15.9"x6.45"x6.89")	AC24V, 1.5A 106x70x56.5mm (4.17"x2.76"x2.22")	AC24V, 3A 120x80x63.5mm (4.72"x3.15"x2.15")	AC24V, 5A 120x102x80mm (4.72"x4.0"x3.15")









ACCESSORIES









Lenses							Testers	
Model	PLZ1040-D	PFL0550-E6D	PLZ20C0-D	PLZ21C0-D	PFL1575-A12D	PFL2070-J12M	PFM900-E	PFM907
Appearance								
Description	Image size: 1/2.7" Aperture: F1.6 Focus length: 2.7-12mm Mount: CS Resolution: 4MP	Image size: 1/2.7" Aperture: F1.6 Focus length: 5-50mm Mount: CS Resolution: 6MP	Image size: 1/1.7" Aperture: F1.5 Focus length: 3.7-16mm Mount: CS Resolution: 12MP	Image size: 1/1.7" Aperture: F1.5 Focus length: 10.5-42mm Mount: CS Resolution: 12MP	Image size: 1/1.7" Aperture: F1.5 Focus length: 15-75mm Mount: C Resolution: 12MP	Image size: 4/3" Aperture: F1.5 Focus length: 20-70mm Mount: M43 Resolution: 12MP	For IPC, HDCVI, TVI, AHD analog camera TDR, analog video generator Digital multimeter, data monitor PoE+, DC12V/2A output	For IPC, HDCVI, TVI, AHD, CVBS camera Wifi test, network cable test Digital multimeter, OPM, data monitor Analog video generator PoE+, DC12V/2A, USB5V/2A output

Pickups						Window Intercom	Radar System	SD Cards	SSD
Model	HAP100	HAP120	HAP200	HAP320	HAP320-V	HAT200-N2	PFM861-100/300	PFM110/111/112/113	TSXGSSD230S/TSXGSSD420K
Appearance									
Description	Input DC12V Scope: 5-40m ² Sensitivity: -40dB 63x30x22mm (2.48"x1.18"x0.87")	Input DC12V Scope: 10-70m ² Sensitivity: -34dB Φ40mmx20mm (Φ1.57"x0.79")	Input DC12V Scope: 10-100 m ² Sensitivity: -30dB 79.6x79.6x21.5mm (3.13"x3.13"x0.85")	Input DC12V Scope: 10-150m ² Sensitivity: -35dB Φ80mmx20mm (Φ3.15"x0.79")	Input DC12V Scope: 5-100m ² Sensitivity: -24dB Φ80mmx23.5mm (Φ3.15"x0.93")	Window Intercom HDCVI 1080P video capture Support full duplex intercom Support NVR storage	Phased Array Radar 100m/300m for people detection Support linking PTZ for trace drawing, low false&missing alarm rate	Brand: Dahua Property/Speed: Class 10 (reading: 90MB/s, writing: 20MB/s) Storage capacity: 16/32/64/128GB	Brand: Transcend Consumer/Industrial grade SSD SATA 2.5" Storage capacity: 128G/256G/512G/1T

Power Adapters					Distributed Power Supplies		UPS	Video Extension	
Model	DC Power				PFM320S Series	PFM34x Series	PFM35x Series		PFM700-E
Appearance									
Description	AC90~264V input DC12V, 1A output -30°C~+70°C CE/FCC/UL/PSE/CCC	AC90~264V input DC12V, 2A output -10°C~+55°C CE/FCC/UL/CCC	AC90~264V input DC12V, 1.5A output -30°C~+70°C Perfect with PFA12X series(IP66)	AC180~264V input DC12V, 2A output -30°C~+70°C Structural water-proof	AC90~264V/AC88~132V &176~264V input DC12V, 50W/150W & DC24V, 75W output	5/9/19 Channel AC90~264V input DC12V, 4A/5A/10A/20A output	Line-Interactive 600VA/360W 1500VA/900W 2-6ms transfer time	Smart Online 1000VA/900W 0ms transfer time	HDMI Extender DC5V for transmitter 1080P/60m Transmitter: 1 in/ 2 out Receiver: 1 out

ACCESSORIES

Cables								
Model	PFM920I-5EUN	PFM920I-5EU	PFM920I-6UN	PFM920I-6U	PFM923I-5EUN	PFM923I-5EU	PFM923I-6UN	PFM923I-6U
Appearance								
Description	UTP CAT5E Cable Conductor: OFC Jacket: PVC(CPR), 4.7mm Color: orange/white Length: 305m(1000.7ft)	UTP CAT5E Cable Conductor: OFC Jacket: PVC(CPR/UL), 5.0mm Color: orange/white Length: 305m(1000.7ft)	UTP CAT6 Cable Conductor: OFC Jacket: PVC(CPR/UL), 6.0mm Color: orange/white Length: 305m(1000.7ft)	UTP CAT6 Cable Conductor: OFC Jacket: PVC(CPR/UL), 6.3mm Color: orange/white Length: 305m(1000.7ft)	UTP CAT5E Cable Conductor: OFC Jacket: LSZH(CPR), 4.6mm Color: white Length: 305m(1000.7ft)	UTP CAT5E Cable Conductor: OFC Jacket: LSZH(CPR), 5.0mm Color: white Length: 305m(1000.7ft)	UTP CAT6 Cable Conductor: OFC Jacket: LSZH(CPR), 6.0mm Color: white Length: 305m(1000.7ft)	UTP CAT6 Cable Conductor: OFC Jacket: LSZH(CPR), 6.3mm Color: white Length: 305m(1000.7ft)

Cabling								
Model	PFC200-6U	PFC200-12U	PFC610	PDU	PFM970-5EU/6U	PFM972-5EU/6U-X	PFM971-1/2	PFM973M-5EU/6-24
Appearance								
Description	19" 6U Rack Cabinet Supports wall & plane mount Depth: 450mm/600mm(17.72"/23.62") Total load bearing: 40kg(88.18lb) Shaft load bearing: 40kg(88.18lb)	19" 12U Rack Cabinet Supports wall & plane mount Depth: 600mm/800mm(23.62"/31.5") Total load bearing: 80kg(176.37lb) Shaft load bearing: 40kg(88.18lb)	19" Rackmount Tray Load bearing: 40kg(88.18lb)	8 Outlet Rackmount PDU Power Strip	UTP CAT5E/6 Information Module	UTP CAT5E/6 Patch Cord Conductor: OFC Jacket: PVC, 5.3mm/6.0mm Color: yellow Length: 1m/2m/3m (3.28ft/6.56ft/9.84ft)	1-Port/2-Port Network Wall Plate	24-port UTP CAT5E/6 Rackmount Patch Panel

Solar Panel			Distribution Box		Gel Battery	Battery Storage Box	Solar Panel Mounting Bracket	Inverter	
Model	ZDNY-330C72	ZDNY-275C60	PFM371-150	PFM377-D2440/D4830	6-CNF-100/150/200	PFM374-H400	PFM376-C/D	TS-400-148A	TS-400-248B
Appearance									
Description	330W Solar Panel Five main grid battery piece Monocrystalline 19.2%	275W Solar Panel Five main grid battery piece Monocrystalline 19.2%	150W Solar Panel Four main grid battery piece Polycrystalline 17.2%	Special Distribution Box Include MPPT controller, lightning arrester, DC circuit breaker, etc.	Rechargeable Gel Battery DC12V 100Ah/150Ah/200Ah	Special Battery Storage Box Engineering PP material 1 box can place 2 batteries	Solar Panel Mounting Bracket	400W Power Inverter Input: DC42~60V Output: Default 400W/110VAC, 100/110/115/120VAC adjustable by setting button	400W Power Inverter Input: DC42~60V Output: Default 400W/230VAC, 200/220/230/240VAC adjustable by setting button

VIDEO MANAGEMENT SOFTWARE

Smart PSS

Smart Professional Surveillance System

Dahua Security Management Platform



Supported OS	Windows/Mac OSx
Supported Devices	CCTV/VDP/ACS
Number of Devices	64
Number of Channels	256
Number of Screens	4
Recording Channels	32
Languages	35
Supported VTO	64
Supported VTH	256
Supported Access Controllers	64
Supported Doors	1000
Basic Functions	Preview, Record, Playback, Export, Snapshot, Instant Playback
Smart Features	Fisheye Correction, People Counting, Smart Search, E-Map, E-PTZ, Smart Track, IVS, Face Detection
Smart Building	Video Intercom, Access Control, Attendance

DMSS

Digital Mobile Surveillance System

Monitor Anything with Your SmartPhone or Tablet Anytime, Anywhere



Devices	Supported Devices	DVR, NVR, IPC, VTO
	Add Device Method	IP/domain, SN, Import from cloud
	Features	Remote config, Alarm config, HDD info, Share device list
Video	Compression Format	H.265/H.264/MPEG-4/JPEG
	Display Resolution	Up to 1920x1080
Live Preview	Max. Channels Can Be Opened at The Same Time	256
	Features	Snapshot, Record, Instant playback, PTZ, Stream control, Talk, Audio, Alarm, Color, Favorites, Remember channels
Playback	Video Playback Duration	72 hours
	Features	Snapshot, Record, Speed up / slow down, Frame-by-frame, Cut
Alarm Push	Alarm Type	Motion detect, Camera masking, Local alarm, Disk alarm (no disk, Low space, disk Error), Face detection, Ivs alarm
	Push Type	Video, Preview, Image

VIDEO MANAGEMENT SOFTWARE

Easy4ip Cloud

The most user-friendly cloud surveillance platform



Web Client

Mobile

Easy4ip is a cloud computing-based video management platform. Easy4ip connects millions of devices, including cameras, doorbells, alarms, etc., over a single global cloud network. It is widely used in video surveillance, smart home, smart building, and education applications. Easy4ip supports multiple services, such as live streaming, broadcasting, video on demand, cloud storage, cloud-based device upgrade, alarm notifications, video analytics, etc. Easy4ip is also an open system which features SDKs for device developers and system integrators to create their own video systems.



Remote Live Streaming

Monitor anytime, anywhere from your mobile device or PC



Cloud Upgrade

Upgrade device firmware remotely, keeping devices up-to-date



Cloud Storage

Alarm video is stored in the cloud, ensuring you don't miss a thing



Alarm Notifications

Stay informed of what's happening in your home or at the store while on the go



Global Server Network

Hybrid cloud includes Amazon, Azure, and other server providers, guaranteeing speed and stability



Security

Several security policies to secure your personal data



DORI DISTANCE (D/O/R/I)

Find the Optimal Camera for Your Individual Surveillance Needs
 The DORI distance is a “general proximity” of distance which makes it easy to pinpoint the right camera for your needs. The DORI distance is calculated based on sensor

specification and lab test results according to EN 62676-4 which defines the criteria for Detect, Observe, Recognize, and Identify, respectively.

- Detect: 25ppm
- Observe: 63ppm
- Recognize: 125ppm
- Identify: 250ppm

NETWORK CAMERAS

Eco-savvy 3.0

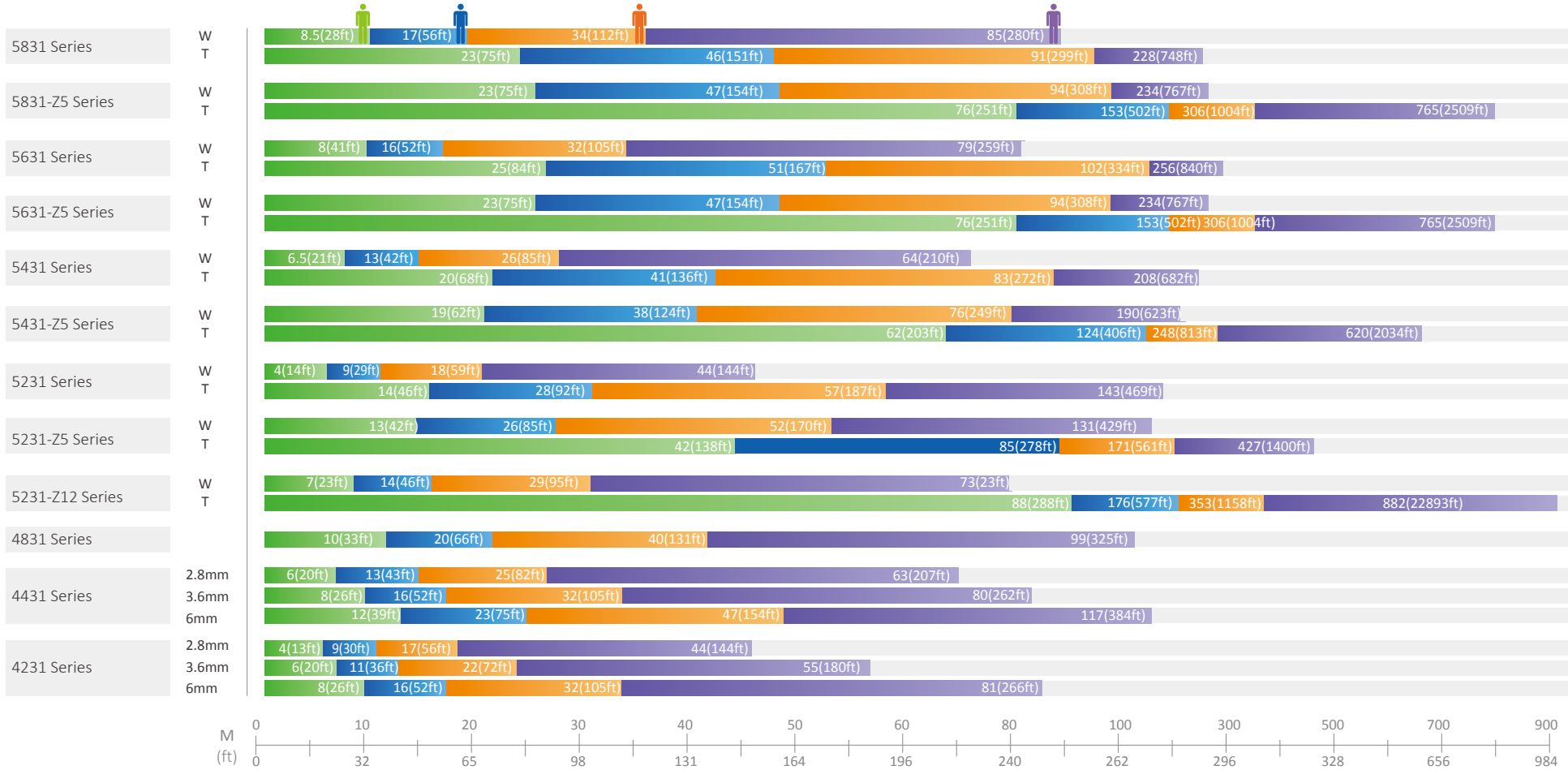

DORI DISTANCE (D/O/R/I)

NETWORK CAMERAS

Pin-hole Series

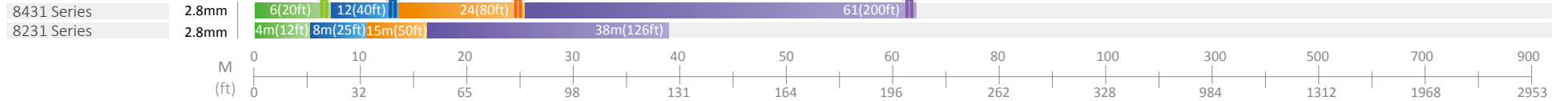

Ultra Smart

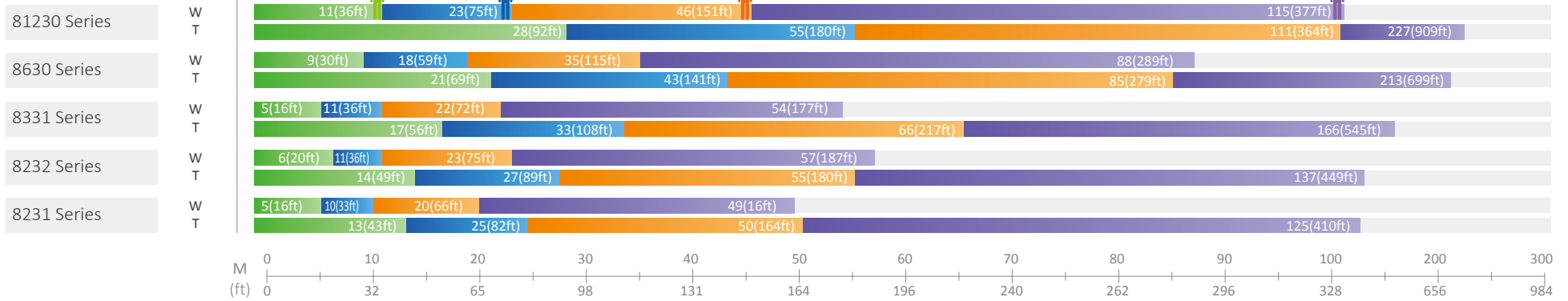

Lite Series

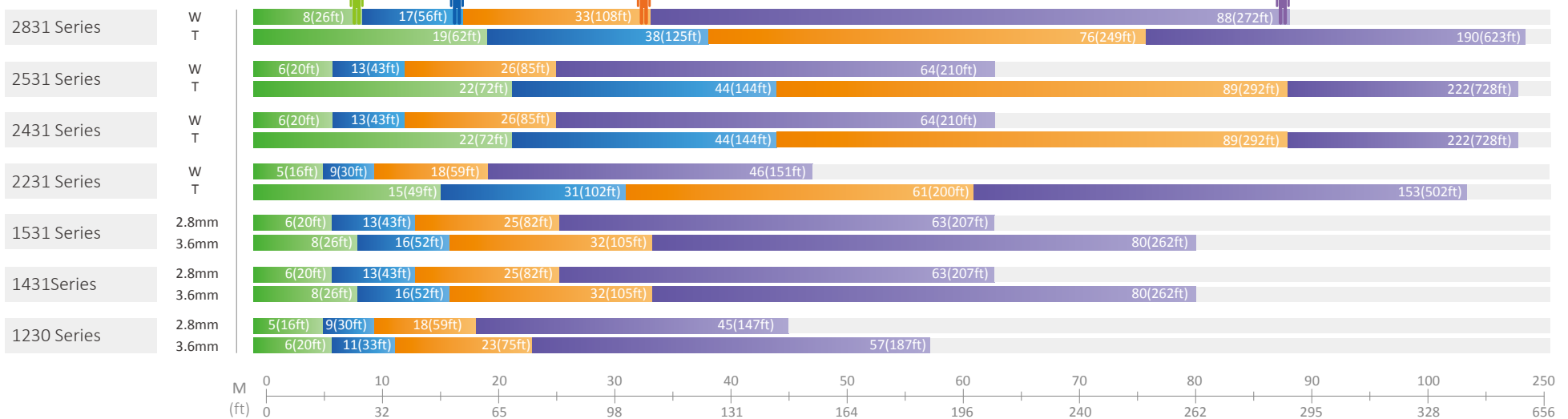

DORI DISTANCE (D/O/R/I)

NETWORK CAMERAS

Panoramic Series

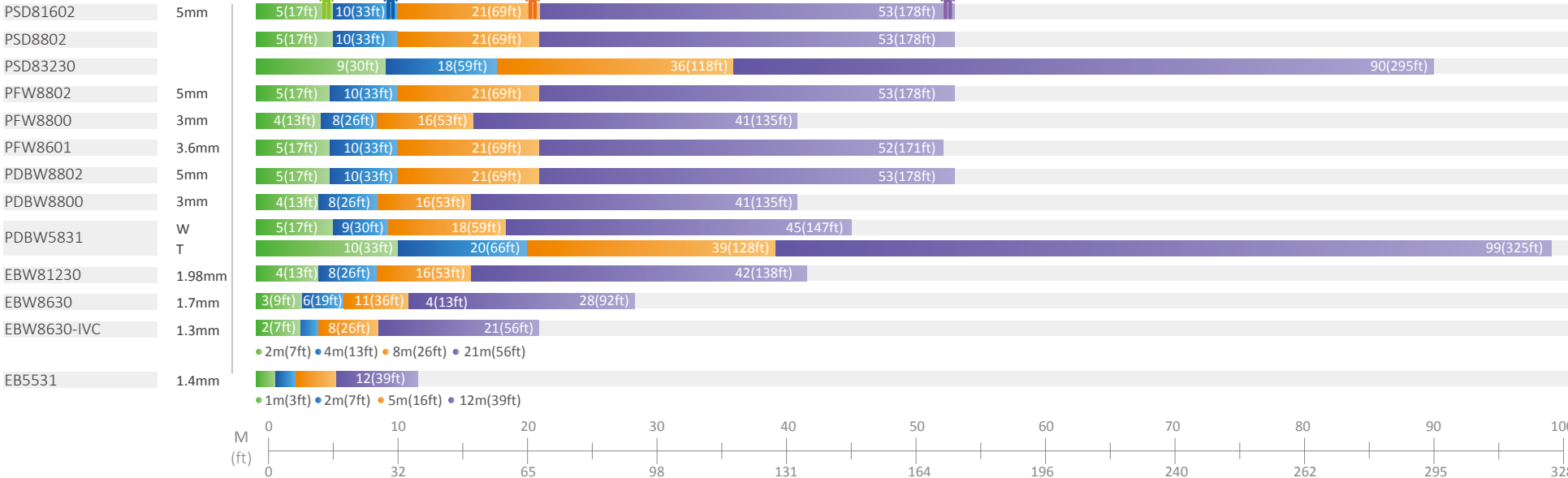

NETWORK PTZ CAMERAS

Ultra Series

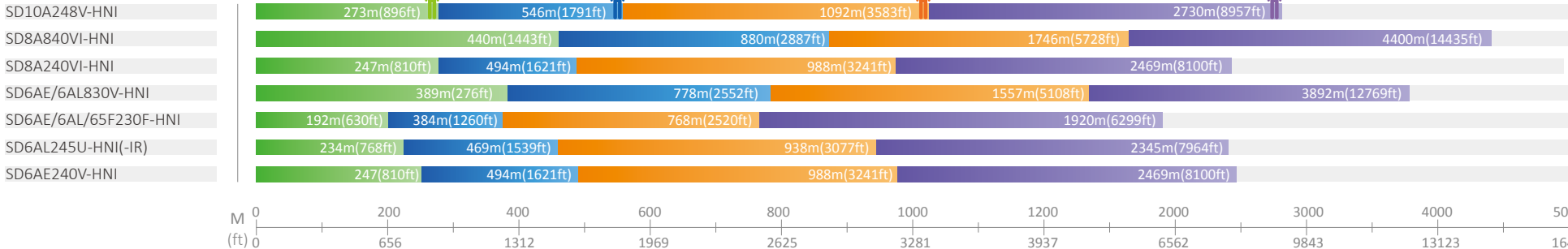

DORI DISTANCE (D/O/R/I)

DORI DISTANCE (D/O/R/I)

NETWORK PTZ CAMERAS

Pro Series

- SD6CE245U-HNI
- SD6C/60/59/50/52C430U-HNI
- SD6CE/6C/60/59/50/52C230U-HNI, SDZ(W)2030S-N
- SD6CE/6C/60/59/50/52C225U-HNI

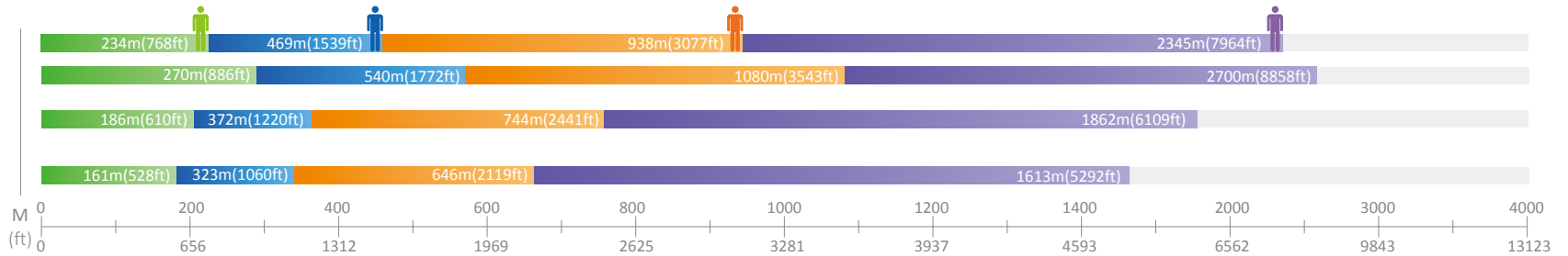

Lite Series / Wi-Fi Series

- SD49412T-HN
- SD49225T-HN(-W)
- SD49/40/42/42C212T-HN
- SD29204T-GN(-W)
- SD22204T-GN(-W)
- SD22404T-GN(-W)
- SD1A/12203T-GN(-W)
- SD1A/12200T-GN(-W)

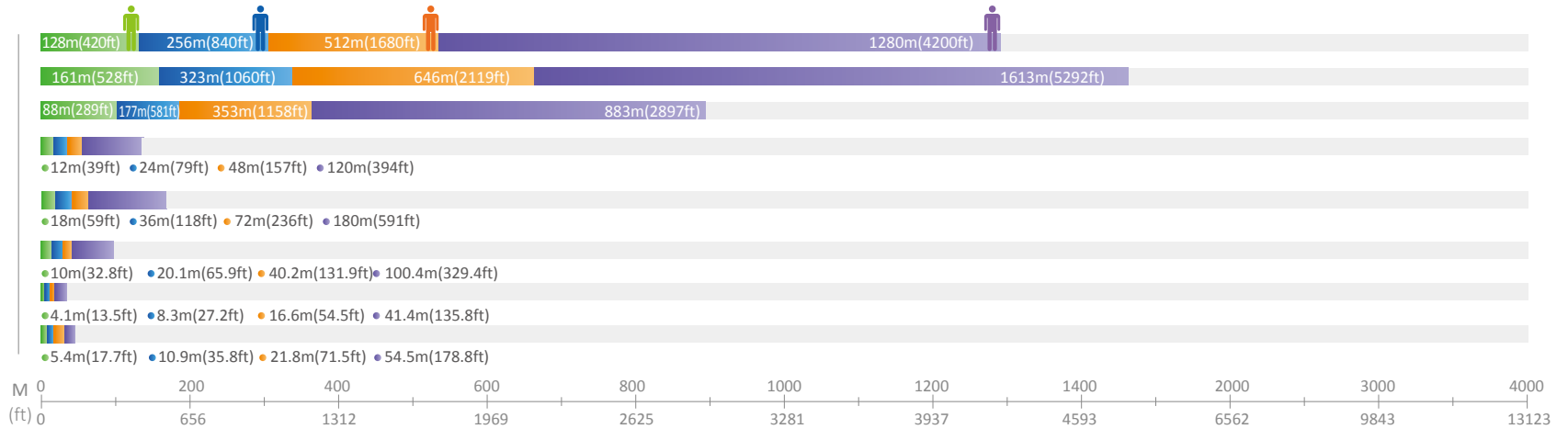

All-environment Series

- PTZ12248V-IRB-N
- PTZ12248V-LR8-N
- PTZ12230F-IRB-N
- PTZ12230F-LR8-N
- PTZ19245U-IRB-N(-B)
- PTZ19240V-IRB-N(-B)
- PTZ1A225U-IRA-N
- SD60230U-HNI-SL, SDZW2030U-SL, EPC230U
- SDZW2000T-SL

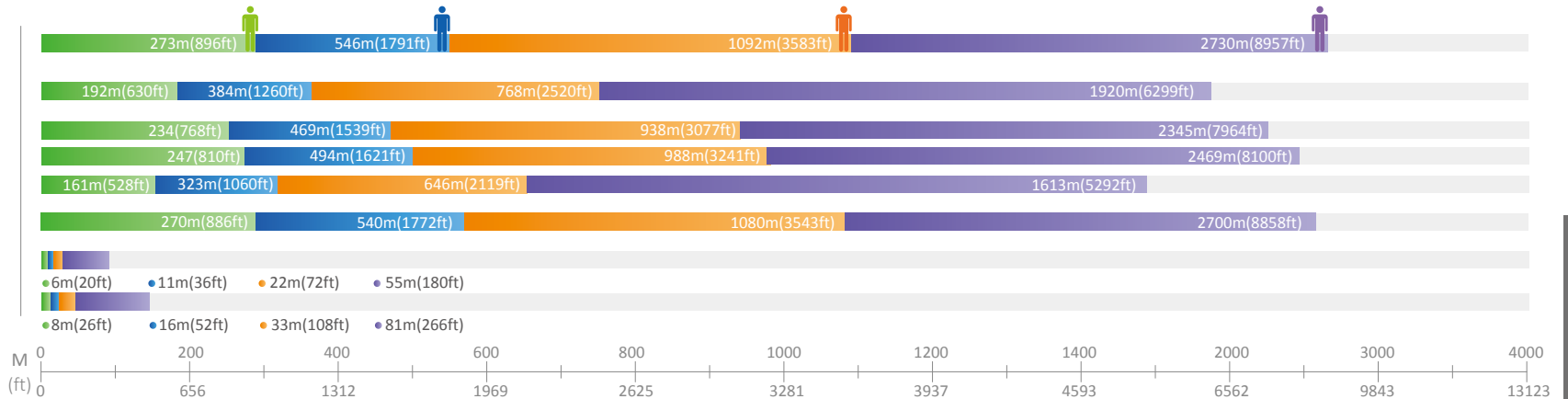

ENABLING A SAFER SOCIETY AND SMARTER LIVING

Dahua Mexico

Tel: +52 55 67231936
Email: sales.mx@dahuatech.com
support.mx@dahuatech.com

Dahua Colombia

Tel: +571 7446110
Email: sales.co@dahuatech.com
support.co@dahuatech.com

Dahua Brazil

Tel: +55 11 32511871
Vendas: comercial.br@dahuatech.com
Suporte Técnico: suporte.br@dahuatech.com

Dahua Perú

Tel: +511 500-8555
Email: sales.pe@dahuatech.com
support.pe@dahuatech.com

Dahua Chile

Tel: +56 232705421
Email: sales.cl@dahuatech.com
support.chile@dahuatech.com

Dahua Argentina

Email: project.ar@dahuatech.com

Dahua Panama

Email: sales.pa@dahuatech.com
Support: support.pa@dahuatech.com

Dahua Thailand

Tel: +66 2541 5188
Email: info.th@dahuatech.com
hr.th@dahuatech.com

Dahua Singapore

Tel: +65 65380952
Email: sales.sg@dahuatech.com

Dahua Turkey

Email: sales.tr@dahuatech.com
support.tr@dahuatech.com

Dahua Malaysia

Tel: +60376620731
Email: sales.my@dahuatech.com

Dahua Indonesia

Email: sales.id@dahuatech.com
support.id@dahuatech.com

Dahua S. Korea

Tel: +82 7081618889
Email: sales.kr@dahuatech.com
support.kr@dahuatech.com

Dahua India

Tel: +91 1244569100
Email: sales.india@dahuatech.com

Dahua Russia

Tel: 8 (499) 682-60-00
Email: info@dahuatech.com

Dahua Kazakhstan

Tel: +7 727 3110838
Email: sales.kz@dahuatech.com

Dahua UK

Tel: +44 (0) 1628 673 667
Email: sales.uk@dahuatech.com

Dahua the Netherlands

Tel: +31 (0) 79 799 96 96
Email: sales.benelux@dahuatech.com

Dahua Iberia

Tel: +34 917649862
Email: sales.iberia@dahuatech.com

Dahua Italy

Tel: +39 3703446609
Email: sales.italy@dahuatech.com

Dahua Germany

Tel: +49 211 20544121
Email: sales.de@dahuatech.com

Dahua France

+33 1 48 53 70 53
Email: sales.france@dahuatech.com

Dahua CEE & Nordic

Tel: +48 223957400
Email: dh.cen@dahuatech.com

Dahua Poland

Tel: +48 223957400
Email: biuro.pl@dahuatech.com

Dahua SRB

+38 1 (11) 4429999
Email: dh.srb@dahuatech.com

Dahua Denmark

Email: Nordic.ne@dahuatech.com

Dahua Hungary

Tel: +36 17899852
Email: sales.hu@dahuatech.com

Dahua Bulgaria

Tel: +35929950013
Email: support.bg@dahuatech.com

Dahua SRL

Email: marketing.ro@dahuatech.com

Dahua Czech

Tel: +420 225 986 001
Email: admin.cz@dahuatech.com

Dahua S. Africa

Email: sales.za@dahuatech.com

Dahua Australia

Tel: +61 299285200
Email: sales.oc@dahuatech.com

Dahua Middle East

Tel: +971 48815300
Email: sales.me@dahuatech.com
info.me@dahuatech.com

* Design and specifications are subject to change without notice.

IP VIDEO PRODUCT SELECTION - 01, Jul 2018

**DAHUA TECHNOLOGY**

No.1199 Bin'an Road, Binjiang District, Hangzhou, China. 310053
Tel: +86-571-87688883 Fax: +86-571-87688815
Email: overseas@dahuatech.com
www.dahuasecurity.com



© Dahua Technology, All rights reserved